



USER MANUAL

POWER QUALITY ANALYZER PQM-700



**SONEL S.A.
Wokulskiego 11
58-100 Świdnica
Poland**

Version 1.15.3 12.04.2021



Due to continuous product development, the manufacturer reserves the right to make changes to functionality, features and technical parameters of the analyzers. This manual describes the firm-ware version 1.15 and the Sonel Analysis v4.4.8 software.

CONTENTS











1	General Information	6
1.1	Safety	7
1.2	General characteristics	8
1.3	Power supply of the analyzer	9
1.4	Tightness and outdoor operation	10
1.5	Mounting on DIN rail	11
1.6	Measured parameters	12
1.7	Compliance with standards	14
2	Operation of the analyzer	15
2.1	Buttons	15
2.2	Signalling LEDs	15
2.3	Switching the analyzer ON/OFF	15
2.4	Auto-off	16
2.5	PC connection and data transmission	16
2.6	Indication of connection error	17
2.7	Warning about too high voltage or current	18
2.8	Taking measurements	18
2.8.1	Start / stop of recording	18
2.8.2	Inrush current measurement	18
2.8.3	Approximate recording times	18
2.9	Measuring arrangements	19
2.10	Key Lock	25
2.11	Sleep mode	25
2.12	Firmware update	25
2.12.1	Automatic update	25
2.12.2	Manual update	26
3	"Sonel Analysis" software	26
4	Design and measurement methods	27
4.1	Voltage inputs	27
4.2	Current inputs	27
4.2.1	Digital integrator	27
4.3	Signal sampling	28
4.4	PLL synchronization	28
4.5	Frequency measurement	29
4.6	Harmonic components measuring method	29
4.7	Event detection	30
5	Calculation formulas	33
5.1	One-phase network	33
5.2	Split-phase network	36
5.3	3-phase wye network with N conductor	38
5.4	3-phase wye and delta network without neutral conductor	41
5.5	Methods of parameter's averaging	43
6	Power Quality - a guide	43
6.1	Basic Information	43
6.2	Current measurement	44
6.2.1	Current transformer clamps (CT) for AC measurements	44

6.2.2	AC/DC measurement clamps.....	45
6.2.3	Flexible current probes	45
6.3	Flicker	46
6.4	Power measurement.....	47
6.4.1	Active power.....	47
6.4.2	Reactive power.....	48
6.4.3	Reactive power and three-wire systems.....	51
6.4.4	Reactive power and reactive energy meters	51
6.4.5	4-quadrant reactive energy measurement.....	52
6.4.6	Apparent power	54
6.4.7	Distortion power D_B and effective nonfundamental apparent power S_{eN}	55
6.4.8	Power factor	55
6.5	Harmonics.....	57
6.5.1	Harmonics characteristics in three-phase system	58
6.5.2	THD.....	59
6.5.3	TDD - Total Demand Distortion.....	60
6.6	Unbalance.....	61
6.7	Detection of voltage dip, swell and interruption.....	62
6.8	CBEMA and ANSI curves.....	64
6.9	Averaging the measurement results.....	65
7	Technical specifications	67
7.1	Inputs	67
7.2	Sampling and RTC.....	68
7.3	Measured parameters - accuracy, resolution and ranges	68
7.3.1	Reference conditions	68
7.3.2	Voltage	69
7.3.3	Current	69
7.3.4	Frequency	70
7.3.5	Harmonics	70
7.3.6	Power and energy.....	70
7.3.7	Estimating the uncertainty of power and energy measurements.....	71
7.3.8	Flicker.....	72
7.3.9	Unbalance	73
7.4	Event detection - voltage and current RMS.....	73
7.5	Event detection - other parameters.....	73
7.5.1	Event detection hysteresis	74
7.6	Inrush current measurement	74
7.7	Recording.....	74
7.8	Power supply, battery and heater.....	75
7.9	Supported networks	76
7.10	Supported current clamps	76
7.11	Communication	76
7.12	Environmental conditions and other technical data	77
7.13	Safety and electromagnetic compatibility	77
7.14	Standards.....	78
8	Accessories	79
8.1	Standard accessories (non-US model version).....	79
8.2	Standard accessories (US model version).....	79
8.3	Optional accessories.....	80
8.3.1	C-4(A) current probe.....	80

8.3.2	C-5A current probe	81
8.3.3	C-6(A) current probe.....	84
8.3.4	C-7(A) current probe.....	85
8.3.5	F-1(A), F-2(A), F-3(A) current probes.....	86
8.3.6	Flexible current probes F-1A6, F-2A6, F-3A6 (6 kA).....	88
8.3.7	Flexible current probes F-1A1, F-2A1, F-3A1 (1.5 kA).....	88
9	Other information.....	89
9.1	Cleaning and maintenance.....	89
9.2	Storage	89
9.3	Dismantling and disposal	89
9.4	Manufacturer.....	89
10	Laboratory services.....	90

1 General Information

The following international symbols are used on the analyzer and in this manual:

	Warning; See explanation in manual		Functional earth terminal		Alternating voltage/ current
	Direct voltage/ current		Double Insulation (Protection Class)		Conforms to relevant European Union direc- tives (Conformité Européenne)
	Do not dispose of this product as un- sorted municipal waste		Recycling information		Conforms to relevant Australian standards
	<p>UL/cUL Safety Certification Mark</p> <p>The PQM-700 (US model) analyzer has been investigated and certified by Underwriters Laboratories (UL) in accordance with the following Standards: UL 61010-1, 3rd Edition, May 11, 2012, Revised July 15 2015, IEC 61010-2-030: 2010 (First Edition), UL 61010-2-030: 2012 (First Edition), CAN/CSA-C22.2 No. 61010-1-12, 3rd Edition, Revision dated July 2015, CAN/CSA-C22.2 No. 61010-2-030-12 (First Edition).</p> <p>It is UL/cUL listed under the UL File: E490376.</p>				

1.1 Safety



To avoid electric shock or fire, you must observe the following guidelines:

- Before you proceed to operate the analyzer, acquaint yourself thoroughly with the present manual and observe the safety regulations and specifications provided by the producer.
- Any application that differs from those specified in the present manual may result in damage to the device and constitute a source of danger for the user.
- Analyzers must be operated only by appropriately qualified personnel with relevant certificates authorizing the personnel to perform works on electric systems. Operating the analyzer by unauthorized personnel may result in damage to the device and constitute a source of danger for the user.
- The device must not be used for networks and devices in areas with special conditions, e.g. fire-risk and explosive-risk areas.
- Before starting the work, check the analyzer, wires, current probes and other accessories for any sign of mechanical damage. Pay special attention to the connectors.
- It is unacceptable to operate the device when:
 - ⇒ it is damaged and completely or partially out of order,
 - ⇒ its cords and cables have damaged insulation,
 - ⇒ of the device and accessories mechanically damaged.
- Do not power the analyzer from sources other than those listed in this manual.
- Do not connect inputs of the analyzer to voltages higher than the rated values.
- Use accessories and probes with a suitable rating and measuring category for the tested circuit.
- Do not exceed the rated parameters of the lowest measurement category (CAT) of the used measurement set consisting of the analyzer, probes and accessories. The measurement category of the entire set is the same as of the component with the lowest measurement category.
- If possible, connect the analyzer to the de-energized circuits.
- Opening the device socket plugs results in the loss of its tightness, leading to a possible damage in adverse weather conditions. It may also expose the user to the risk of electric shock.
- Do not handle or move the device while holding it only by its cables.
- Do not unscrew the nuts from the cable glands, as they are permanently fixed. Unscrewing the nuts will void the guarantee.
- Repairs may be performed only by an authorized service point.

The analyzer is equipped with an internal Li-Ion battery, which has been tested by an independent laboratory and is quality-certified for compliance with the standard *UN Manual of Tests and Criteria Part III Subsection 38.3 (ST/SG/AC.10/11/Rev.5)*. Therefore, the analyzer is approved for air, maritime and road transport.

1.2 General characteristics

Power Quality Analyzer PQM-700 (Fig. 1) is a high-tech device providing its users with a comprehensive features for measuring, analysing and recording parameters of 50/60 Hz power networks and power quality in accordance with the European Standard EN 50160. The analyzer is fully compliant with the requirements of IEC 61000-4-30, Class S.

The device is equipped with four cables terminated with banana plugs, marked as L1, L2, L3, N. The range of voltages measured by the four measurement channels is max. ± 1150 V. This range may be extended by using external voltage transducers.

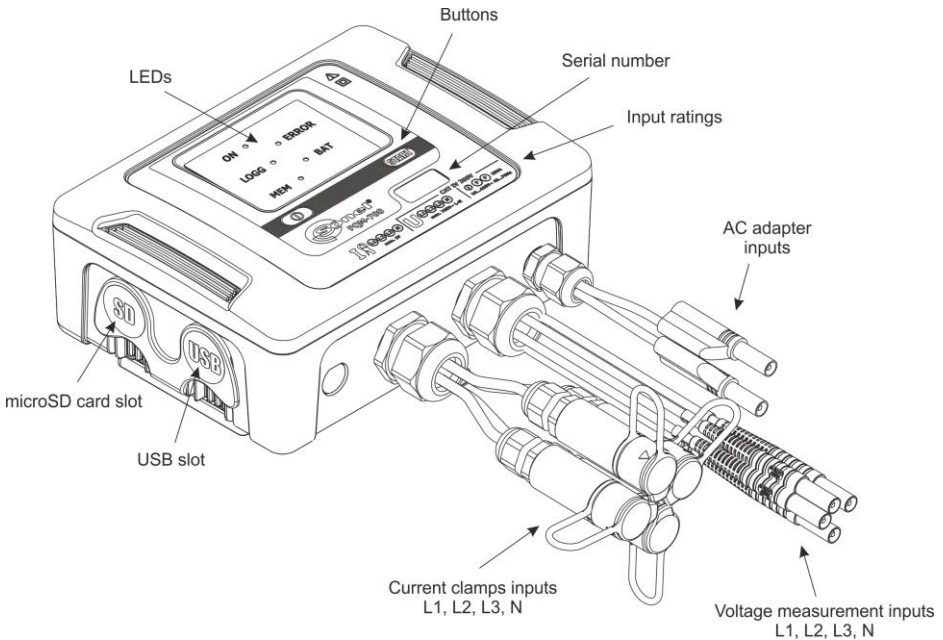

Fig. 1. Power Quality Analyzer PQM-700. General view.

Current measurements are carried out using four current inputs installed on short cables terminated with clamp terminals. The terminals may be connected to the following clamp types: flexible claps (marked as F-1(A), F-2(A), F-3(A)) with nominal rating up to 3000 A (differing from others only by coil diameter); and CT clamps marked as C-4(A) (range up to 1000 A AC), C-5(A) (up to 1000 A AC/DC), C-6(A) (up to 10 A AC) and C-7(A) (up to 100 A AC). The values of nominal measured currents may be changed by using additional transducers - for example, using a transducer of 1000:5 ratio, the user may select C-6(A) clamps to measure currents up to 1000 A.

The device has a built-in 2 GB microSD memory card. Data from the memory card may be read via USB slot or by an external reader.

Note

microSD card may be removed only when the analyzer is turned off. Removing the card during the operation of the analyser may result in the loss of important data.

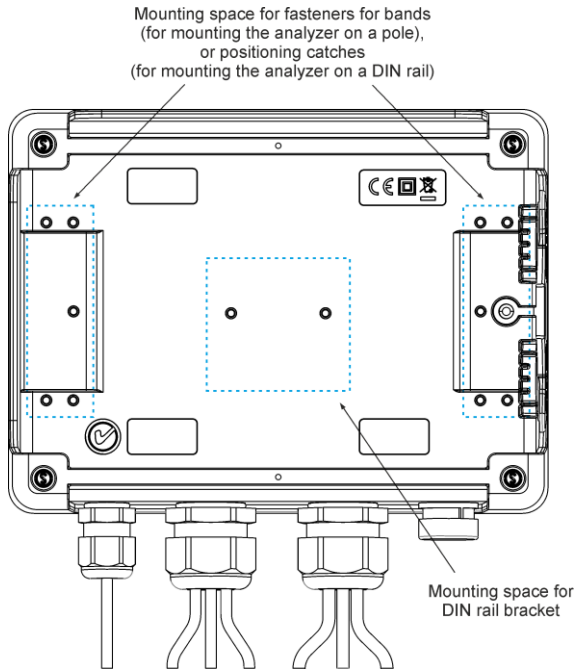

Fig. 2. The rear wall of PQM-700 analyzer.

Recorded parameters are divided into groups that may be independently turned on/off for re-recording purposes and this solution facilitates the rational management of the space on the memory card. Parameters that are not recorded, leave more memory space for further measurements.

PQM-700 has an internal power supply adapter operating in a wide input voltage range (100...415 V AC / 140...415 V DC), which is provided with independent cables terminated with banana plugs.

An important feature of the device is its ability to operate in harsh weather conditions – the analyzer may be installed directly on electric poles. The ingress protection class of the analyzer is IP65, and operating temperature ranges from -20°C to +55°C.

Uninterrupted operation of the device (in case of power failure) is ensured by an internal rechargeable lithium-ion battery.

The user interface consists of five LEDs and 2 buttons.

The full potential of the device may be released by using dedicated PC software *Sonel Analysis*.

Communication with a PC is possible via USB connection, which provides the transmission speed up to 921.6 kbit/s

1.3 Power supply of the analyzer

The analyzer has a built-in power adapter with nominal voltage range of 100...415 V AC / 140...415 V DC (90...460 V AC / 127...460 V DC including fluctuations). The power adapter has independent terminals (red cables) marked with letter P (*power*). To prevent the power adapter from being damaged by undervoltage, it automatically switches off when powered with input voltages below approx. 80 V AC (110 V DC).

1 General Information

To maintain power supply to the device during power outages, the internal rechargeable battery is used. It is charged when the voltage is present at terminals of the AC adapter. The battery is able to maintain power supply up to 6 hours at temperatures of -20°C ... $+55^{\circ}\text{C}$. After the battery is discharged the meter stops its current operations (e.g. recording) and switches off in the emergency mode. When the power supply from mains returns, the analyzer resumes interrupted recording.

Note

The battery may be replaced only by the manufacturer's service department.

1.4 Tightness and outdoor operation

PQM-700 analyzer is designed to work in difficult weather conditions – it can be installed directly on electric poles. Two bands with buckles and two plastic fasteners are used for mounting the analyzer. The fasteners are screwed to the back wall of the housing, and bands should be passed through the resulting gaps.

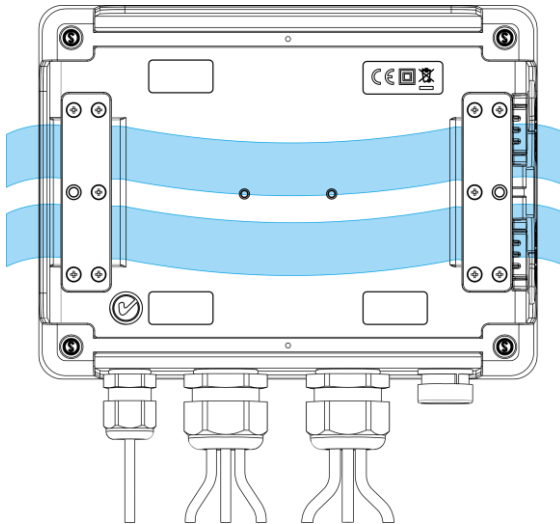

Fig. 3. Fasteners for bands (for mounting the analyzer on a pole)

The ingress protection class of the analyzer is IP65, and operating temperature ranges from -20°C to $+55^{\circ}\text{C}$.



Note

In order to ensure the declared ingress protection class IP65, the following rules must be observed:

- *Tightly insert the stoppers in the slots of USB and microSD card,*
- *Unused clamp terminals must be sealed with silicone stoppers.*

At ambient temperatures below 0°C or when the internal temperature drops below this point, the internal heater of the device is switched on – its task is to keep the internal temperature above zero, when ambient temperatures range from -20°C to 0°C.

The heater is powered from AC/DC adapter, and its power is limited to approx. 5 W.

Due to the characteristics of the built-in lithium-ion rechargeable battery, the process of charging is blocked when the battery temperature is outside the range of 0°C...60°C (in such case, *Sonel Analysis* software indicates charging status as "charging suspended").

1.5 Mounting on DIN rail

The device is supplied with a bracket for mounting the analyzer on a standard DIN rail. The bracket must be fixed to the back of the analyzer with the provided screws. The set includes also positioning catches (in addition to fasteners for mounting the analyzer on a pole), which should be installed to increase the stability of the mounting assembly. These catches have special hooks that are supported on the DIN rail.

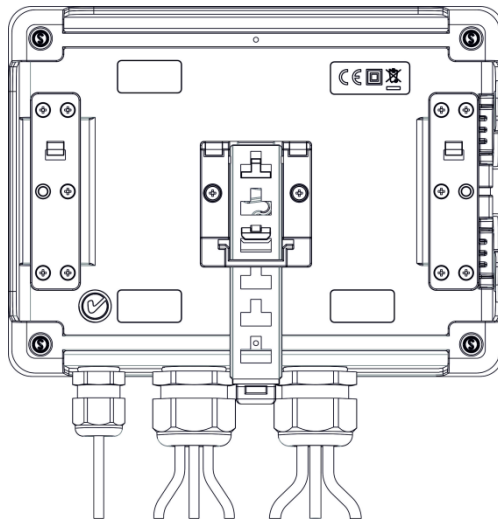

Fig. 4. The rear wall of the analyzer with fixtures for mounting on DIN rail.

1.6 Measured parameters

PQM-700 analyzer is designed to measure and record the following parameters:

- RMS phase and phase-to-phase voltages – up to 760 V (peak voltages ± 1150 V),
- RMS currents: up to 3000 A (peak currents ± 10 kA) using flexible clamps (F-1(A), F-2(A), F-3(A)); up to 1000 A (peak values ± 3600 A) using CT clamps (C-4(A) or C-5(A)); up to 10 A (peak values ± 36 A) using C-6(A) clamps, or up to 100 A (peak values ± 360 A) using C-7(A) clamps,
- crest factors for current and voltage,
- mains frequency within the range of 40...70 Hz,
- active, reactive and apparent power and energy, distortion power,
- harmonics of voltages and currents (up to 40th),
- Total Harmonic Distortion THD_F and THD_R for current and voltage,
- power factor, $\cos\phi$, $\tan\phi$,
- unbalance factors for three-phase mains and symmetrical components,
- flicker P_{ST} and P_{LT} ,
- inrush current for up to 60 s.

Some of the parameters are aggregated (averaged) according to the time selected by the user and may be stored on a memory card. In addition to average value, it is also possible to record minimum and maximum values during the averaging period, and to record the current value occurring in the time of measurement.

The module for event detection is also expanded. According to EN 50160, typical events include voltage dip (reduction of RMS voltage to less than 90% of nominal voltage), swell (exceeding 110% of the nominal value) and interruption (reduction of the supplied voltage below 5% of the nominal voltage) The user does not have to enter the settings defined in EN 50160, as the software provides an automatic configuration of the device to obtain energy measurement mode compliant with EN 50160 The user may also perform manual configuration – the software is fully flexible in this area. Voltage is only one of many parameters for which the limits of event detection may be defined. For example, the analyzer may be configured to detect power factor drop below a defined value, THD exceeding another threshold, and the 9th voltage harmonic exceeding a user-defined percentage value. Each event is recorded along with the time of occurrence. For events that relate to exceeding the pre-defined limits for voltage dip, swell, interruption, and exceeding minimum and maximum current values, the recorded information may also include a waveform for voltage and current. It is possible to save two periods before the event, and four after the event.

A very wide range of configurations, including a multitude of measured parameters make PQM-700 analyzer an extremely useful and powerful tool for measuring and analysing all kinds of power supply systems and interferences occurring in them. Some of the unique features of this device make it distinguishable from other similar analyzers available in the market.

Tab. 1 presents a summary of parameters measured by PQM-700, depending on the mains type.

Tab. 1. Measured parameters for different network configurations.

Network type, channel Parameter		1-phase		2-phase			3-phase wye with N,					3-phase triangle 3-phase wye without N,				
		L1/A	N	L1/A	L2/B	N	Σ	L1/A	L2/B	L3/C	N	Σ	L12/AB	L23/BC	L31/CA	Σ
U	RMS voltage	•		•	•			•	•	•			•	•	•	
U _{DC}	Voltage DC component	•		•	•			•	•	•			•	•	•	
I	RMS current	•	•	•	•	•		•	•	•	•		•	•	•	
I _{DC}	Current DC component	•	•	•	•	•		•	•	•	•		•	•	•	
F	Frequency	•		•				•					•			
CF U	Voltage crest factor	•		•	•			•	•	•			•	•	•	
CF I	Current crest factor	•	•	•	•	•		•	•	•	•		•	•	•	
P	Active power	•		•	•		•	•	•	•		•				•
Q ₁ , Q _B	Reactive power	•		•	•		•	•	•	•		•				• ⁽¹⁾
D, S _N	Distortion power	•		•	•		•	•	•	•		•				
S	Apparent power	•		•	•		•	•	•	•		•				•
PF	Power Factor	•		•	•		•	•	•	•		•				•
cosφ	Displacement power factor	•		•	•		•	•	•	•		•				
tanφ _{C-} , tanφ _{L+} , tanφ _{L-} , tanφ _{C+}	Tangent φ factor (4-quadrant)	•		•	•		•	•	•	•		•				• ⁽¹⁾
THD U	Voltage Total harmonic distortion	•		•	•			•	•	•			•	•	•	
THD I	Current Total harmonic distortion	•	•	•	•	•		•	•	•	•		•	•	•	
E _{P+} , E _{P-}	Active energy (consumed and supplied)	•		•	•		•	•	•	•		•				•
E _{QC-} , E _{OL+} , E _{QL+} , E _{OC+}	Reactive energy (4-quadrant)	•		•	•		•	•	•	•		•				• ⁽¹⁾
E _s	Apparent energy	•		•	•		•	•	•	•		•				•
U _{h1..U_{h40}}	Voltage harmonic amplitudes	•		•	•			•	•	•			•	•	•	
I _{h1..I_{h40}}	Current harmonic amplitudes	•	•	•	•	•		•	•	•	•		•	•	•	
Unbalance U, I	Symmetrical components and unbalance factors															•
P _{st} , P _{it}	Flicker factors	•		•	•			•	•	•			•	•	•	

Explanations: L1/A, L2/B, L3/C (L12/AB, L23/BC, L31/CA) indicate subsequent phases

N is a measurement for current channel I_N ,

Σ is the total value for the system.

(1) In 3-wire networks, the total reactive power is calculated as inactive power $N = \sqrt{S_e^2 - P^2}$ (see discussion on reactive power in section 6.4)

1.7 Compliance with standards

PQM-700 is designed to meet the requirements of the following standards.

Standards valid for measuring network parameters:

- IEC 61000-4-30:2009 – Electromagnetic compatibility (EMC) - Testing and measurement techniques - Power quality measurement methods,
- IEC 61000-4-7:2002 – Electromagnetic compatibility (EMC) – Testing and Measurement Techniques - General Guide on Harmonics and Interharmonics Measurements and Instrumentation for Power Supply Systems and Equipment Connected to them,
- IEC 61000-4-15:2011 – Electromagnetic compatibility (EMC) – Testing and Measurement Techniques - Flickermeter – Functional and Design Specifications,
- EN 50160:2010 – Voltage characteristics of electricity supplied by public distribution networks.

Safety standards:

- IEC 61010-1 – Safety requirements for electrical equipment for measurement control and laboratory use. Part 1: General requirements

Standards for electromagnetic compatibility:

- IEC 61326 – Electrical equipment for measurement, control and laboratory use. Requirements for electromagnetic compatibility (EMC).



The device meets all the requirements of Class S as defined in IEC 61000-4-30. The summary of the requirements is presented in the table below.

Tab. 2. Summary of selected parameters in terms of their compliance with the standards

Aggregation of measurements at different intervals	IEC 61000-4-30 Class S: <ul style="list-style-type: none"> • Basic measurement time for parameters (voltage, current, harmonics, unbalance) is a 10-period interval for 50 Hz power supply system and 12-period interval for 60 Hz system, • Interval of 3 s (150 periods for the nominal frequency of 50 Hz and 180 periods for 60 Hz), • Interval of 10 minutes.
Real-time clock (RTC) uncertainty	IEC 61000-4-30 Class S: <ul style="list-style-type: none"> • Built-in real-time clock, set via <i>SoneI Analysis</i> software, no GPS/radio synchronization. • Clock accuracy better than ± 0.3 seconds/day
Frequency	Compliant with IEC 61000-4-30 Class S of the measurement method and uncertainty
Power supply voltage	Compliant with IEC 61000-4-30 Class S of the measurement method and uncertainty
Voltage fluctuations (flicker)	The measurement method and uncertainty meets the requirements of IEC 61000-4-15 standard.
Dips, interruptions and swells of supply voltage	Compliant with IEC 61000-4-30 Class S of the measurement method and uncertainty
Supply voltage unbalance	Compliant with IEC 61000-4-30 Class S of the measurement method and uncertainty
Voltage and current harmonics	Measurement method and uncertainty is in accordance with IEC 61000-4-7 Class I

2 Operation of the analyzer

2.1 Buttons





The keyboard of the analyzer consists of two buttons: ON/OFF  and START/STOP . To switch-on the analyzer, press ON/OFF button. START/STOP button is used to start and stop recording.

2.2 Signalling LEDs

The analyzer is equipped with five LEDs that indicate different operating states:

- **ON** (green) – the LED is on when the analyzer is turned on. During recording with activated sleep mode, the LED is off.
- **LOG** (yellow) – indicates recording in process. In standby mode the LED is lit continuously. During recording it flashes. During recording with activated sleep mode – it is off and then switched on in 10-sec. intervals.
- **ERROR** (red) – blinking of this LED indicates a potential problem with connecting to the tested network or the incompatibility of the active configuration with network parameters. Control criteria are defined in chapter 2.6. Continuous light indicates one of the possible internal errors of the analyzer (see also the description of additional statuses presented below).
- **MEM** (red) – when this LED is on, it indicates that the data cannot be recorded on the memory card. **MEM** LED is continuously lit when the entire space on the memory card is filled. See also the description of additional statuses presented below.
- **BATT** (red) - battery status. Blinking indicates that the battery is low (charged in 20% or less). When the battery is completely discharged, LED lights up for 5 seconds (with beep) and then the analyzer is switched off in emergency mode.

Additional statuses indicated by LEDs:

- Continuous light of **MEM** and **ERROR** LEDs – no memory card, the card is damaged or not formatted. When these LEDs are on after inserting a memory card, there are two possible scenarios:
 - the card is damaged or incompatible with the analyzer. In this case there is no possibility of further work with the analyzer. START button  is inactive.
 - the card is not formatted (missing files required by the analyzer or files damaged) – in this case you can press the START button  (it is active), which will start the process of formatting the card (NOTE: all data on the card will be deleted). If the process is successful **MEM** and **ERROR** LEDs will go off and the analyzer will be ready for further work.
- Blinking **ON** LED – FIRMWARE.PQF file detected on the card, containing the correct firmware update file. You may press the START button  to begin the update process. During the update process **ON** and **MEM** LEDs blink simultaneously. After this process is completed, the meter will restart. You may skip the firmware update by pressing the ON/OFF button  or by waiting 10 seconds.

2.3 Switching the analyzer ON/OFF

- The analyzer may be switched-on by pressing button . Green **ON** LED indicates that analyzer is switched on. Then, the analyzer performs a self-test and when an internal fault is detected, **ERROR** LED is lit and a long beep (3 seconds) is emitted – measurements are blocked. After the self-test, the meter begins to test if the connected mains configuration is the same as the configuration in analyzer's memory, and when an error is detected **ERROR** LED



2 Operation of the analyzer

flashes every 0.5 seconds. When **ERROR** LED flashes the analyzer still operates as normal and measurements are possible.

- When the meter is switched on and detects full memory, **MEM** LED is lit – measurements are blocked, only read-out mode for current data remains active.
- When the meter is switched on and fails to detect the micro-SD card or detects its damage, **ERROR** and **MEM** LEDs are lit and measurements are blocked.

Note

The **ERROR** and **MEM** LEDs behaves the same way when a new microSD card has been inserted to the analyzer's slot. To format the card to be usable with PQM-700 analyzer the  (START/STOP) button must be pressed. Analyzer will then confirm start of formatting process with 3 beeps. All the data on the card will be erased. If the formatting finishes successfully the **ERROR** and **MEM** LEDs will switch off, and the analyzer will be ready for further operation.

- If the connection test was successful, after pressing  the meter enters the recording mode, as programmed in the PC.
- To switch the analyzer OFF, keep button  pressed for 2 seconds, when no button or recording lock are active.



2.4 Auto-off

When the analyzer operates for at least 30 minutes powered by the battery (no power supply from mains) and it is not in the recording mode and PC connection is inactive, the device automatically turns-off to prevent discharging the battery.

The analyzer turns off automatically also when the battery is fully discharged. Such an emergency stop is preceded by activating BATT LED for 5 s and it is performed regardless of the current mode of the analyzer. In case of active recording, it will be interrupted. When the power supply returns, the recording process is resumed.



2.5 PC connection and data transmission

When the meter is switched-on, its USB port remains active.

- In the read-out mode for current data, PC software refreshes data with a frequency higher than once every 1 second.
- During the recording process, the meter may transmit data already saved in memory. Data may be read until the data transmission starts.
- During the recording process the user may view mains parameters in PC:
 - instantaneous values of current, voltage, all power values, total values for three phases,
 - harmonics and THD,
 - unbalance,
 - phasor diagrams for voltages and currents,
 - current and voltage waveforms drawn in real-time.
- When connected to a PC, button  is locked, but when the analyzer operates with key lock mode (e.g. during recording),  button is also locked.
- To connect to the analyzer, enter its PIN code. The default code is 000 (three zeros). The PIN code may be changed using *Sonel Analysis* software.
- When wrong PIN is entered three times in a row, data transmission is blocked for 10 minutes. Only after this time, it will be possible to re-entry PIN.

- When within 30 sec of connecting a PC to the device no data exchange occurs between the analyzer and the computer, the analyzer exits data exchange mode and terminates the connection.

Notes

- Holding down buttons  and  for 5 seconds results in an emergency setting of PIN code (000).
- If you the keys are locked during the recording process, this lock has a higher priority (first the user would have to unlock buttons to reset the emergency PIN). This is described in chapter 2.10.

USB is an interface that is continuously active and there is no way to disable it. To connect the analyzer, connect USB cable to your PC (USB slot in the device is located on the left side and is secured with a sealing cap). Before connecting the device, install *Sonel Analysis* software with the drivers on the computer. Transmission speed is 921.6 kbit/s.

2.6 Indication of connection error

During operation, the analyzer continuously monitors the measured parameters for compliance with the current configuration. Basing on several criteria listed below, the analyzer controls the lighting of **ERROR** LED. If the analyzer does not detect any inconsistency, this LED remains off. When at least one of the criteria indicates a potential problem, **ERROR** LED starts to blink.

The criteria used by the analyzer for detecting a connection error are as follows:

- deviation of RMS voltage exceeding $\pm 15\%$ of nominal value,
- deviation of the phase angle of the voltage fundamental component exceeding $\pm 30^\circ$ of the theoretical value with resistive load and symmetrical mains (see note below)
- deviation of the phase angle of the current fundamental component exceeding $\pm 55^\circ$ of the theoretical value with resistive load and symmetrical mains (see note below)
- network frequency deviation exceeding $\pm 10\%$ of the nominal frequency,
- in 3-phase 3- and 4-wire systems the analyzer also calculates the sum of all the currents (instantaneous values) and checks if it totals to zero. This helps in determining if all current probes are connected correctly (i.e. arrows on current probes facing to the load). If the calculated current sum RMS value is higher then 0.3% of I_{nom} it is treated as an error and blinking **ERROR** LED.

Note

To detect a phase error, the fundamental component of the measured sequence must be at least equal to 5% of the nominal voltage, or 1% of the nominal current. If this condition is not fulfilled, the correctness of angles is not verified.





2.7 Warning about too high voltage or current

During its operation, the analyzer monitors continuously the value of voltages and currents connected to the measuring inputs. If the voltage of any active phase exceeds approx. 20% of the nominal voltage ($> 120\% U_{NOM}$) set in the measurement configuration, a two-tone continuous beep is activated. The same applies for currents – an alarm signal is activated if the measured current in any of the active channels exceeds 20% of nominal current (range of clamps; $>120\% I_{NOM}$). In such a situation, check whether the voltage and current in the measured network is within voltage and current limits allowable for the analyzer or check if the analyzer configuration is correct and change it, if necessary.



2.8 Taking measurements

2.8.1 Start / stop of recording

Recording may be triggered in three ways:

- immediate triggering - manually by pressing  button after configuring the meter from a PC – **LOG** LED flashes,
- scheduled triggering - according to time set in the PC. The user must first press  button to enter recording stand-by mode; in this case pressing  button does not trigger the recording process immediately (the meter waits for the first pre-set time and starts automatically). In standby mode **LOG** LED is lit continuously, after triggering it flashes,
- threshold triggering. The user must first press  button to enter recording stand-by mode; in this case pressing  button does not trigger the recording process immediately – the normal recording starts automatically after exceeding any threshold set in the settings. In standby mode **LOG** LED is lit continuously, after triggering it flashes.

Stopping the recording process:

- Recording may be manually stopped by holding for one second button  or from the PC application.
- Recording ends automatically as scheduled (if the end time is set), in other cases the user stops the recording (using button  or the software).
- Recording ends automatically when the memory card is full.
- After finishing the recording, when the meter is not in the sleep mode, **LOG** LED turns off and the meter waits for next operator commands.
- If the meter had LEDs turned-off during the recording process, then after finishing the recording no LED is lit; pressing any button activates **ON** LED.

2.8.2 Inrush current measurement

This function allows user to record half-period values of voltage and current within 60 sec after starting the measurement. After this time, the measurements are automatically stopped. Before the measurement, set aggregation time at $\frac{1}{2}$ period. Other settings and measurement arrangements are not limited.

2.8.3 Approximate recording times

The maximum recording time depends on many factors such as the size of the memory card, averaging time, the type of system, number of recorded parameters, waveforms recording, event detection, and event thresholds. A few selected configurations are given in Tab. 3. The last column presents approximate recording times for 2 GB memory card. The typical configurations shown in Tab. 3 assumes that I_N current measurement is enabled.

Tab. 3. Approximate recording times for a few typical configurations.

Configuration mode/profile	Averaging time	System type (current measurement on)	Events	Event waveforms	Waveforms after averaging period	Approximate recording time with 2GB allocated space
according to EN 50160	10 min	3-phase wye	• (1000 events)	• (1000 events)		60 years
according to the "Voltages and currents" profile	1 s	3-phase wye				270 days
according to the "Power and harmonics" profile	1 s	3-phase wye				23 days
according to the "Power and harmonics" profile	1 s	3-phase wye	• (1000 events)	• (1000 events)		22.5 day
all possible parameters	10 min	3-phase wye				4 years
all possible parameters	10 s	3-phase wye				25 days
all possible parameters	10 s	1-phase				64 days
all possible parameters	10 s	1-phase	• (1000 events / day)	• (1000 events / day)		22 days

2.9 Measuring arrangements

The analyzer may be connected directly and indirectly to the following types of networks:

- 1-phase (Fig. 5),
- 2-phase (split-phase) with split-winding of the transformer (Fig. 6),
- 3-phase wye with a neutral conductor (Fig. 7),
- 3-phase wye without neutral conductor (Fig. 8),
- 3-phase delta (Fig. 9).

In three-wire systems, current may be measured by the Aron method, which uses only two clamps that measure linear currents I_{L1} and I_{L3} . I_{L2} jest current is then calculated using the following formula:

$$I_{L2} = -I_{L1} - I_{L3}$$

This method can be used in delta systems (Fig. 10) and wye systems without a neutral conductor (Fig. 11).

Note

As the voltage measuring channels in the analyzer are referenced to N input, then in systems where the neutral is not present, it is necessary to connect N input to L3 network terminal. In such systems, it is not required to connect L3 input of the analyzer to the tested network. It is shown in Fig. 8, Fig. 9, Fig. 10 and Fig. 11 (three-wire systems of wye and delta type).

2 Operation of the analyzer

In systems with neutral conductor, the user may additionally activate current measurement in this conductor, after installing additional clamps in I_N channel. This measurement is performed after activating in settings the option of **Current in N conductor**.

Note

*In order to correctly calculate total apparent power S_e and total Power Factor (PF) in a 4-wire 3-phase system, it is necessary to measure the current in the neutral conductor. Then it is necessary to activate option **Current in N conductor** and to install 4 clamps as shown in Fig. 7. More information may be found in sec. 6.4.5.*

Pay attention to the direction of current clamps (flexible and CT). The clamps should be installed with the arrow indicating the load direction. It may be verified by checking an active power measurement - in most types of passive receivers active power is positive. When clamps are incorrectly connected, it is possible to change their polarity using *Sonel Analysis* software.

The following figures show schematically how to connect the analyzer to the tested network depending on its type.

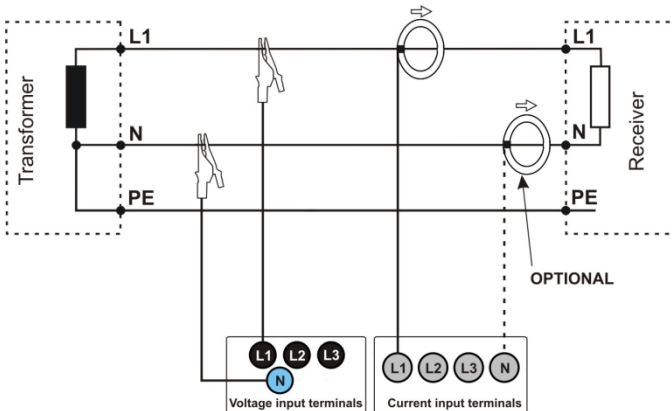

Fig. 5. Wiring diagram – single phase.

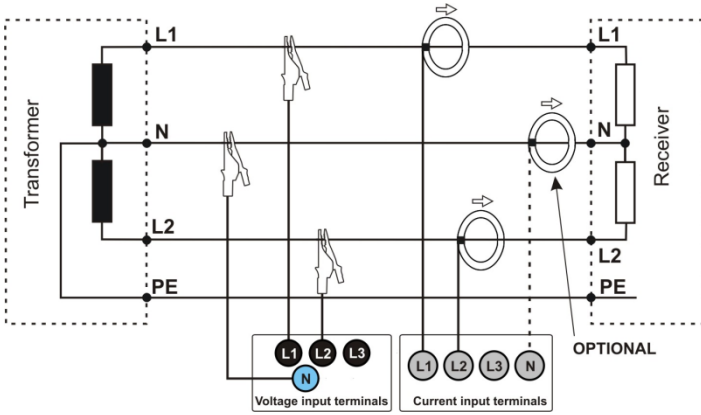

Fig. 6. Wiring diagram – 2-phase.

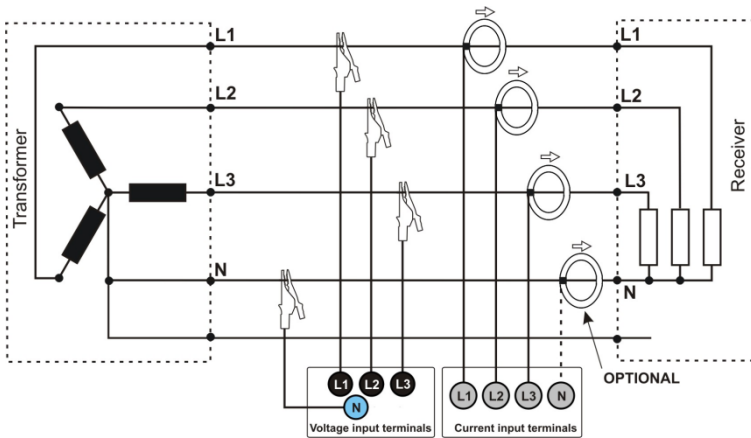

Fig. 7. Wiring diagram – 3-phase wye with a neutral conductor.

2 Operation of the analyzer

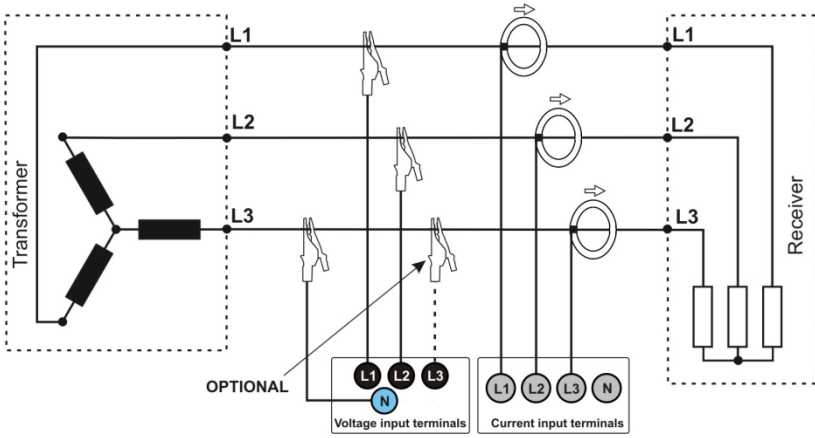

Fig. 8. Wiring diagram – 3-phase wye without neutral conductor.

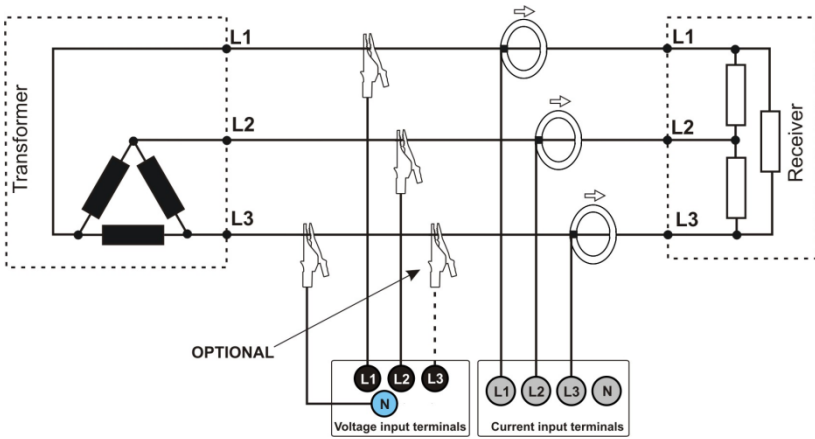

Fig. 9. Wiring diagram – 3-phase delta.

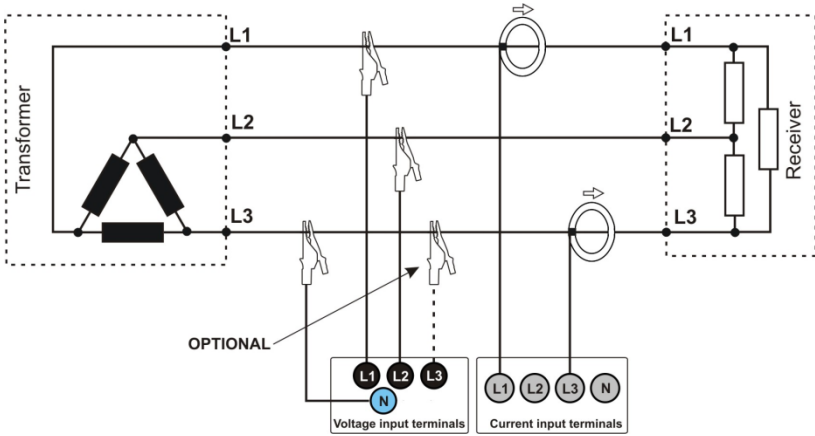

Fig. 10. Wiring diagram – 3-phase delta (current measurement using Aron method).

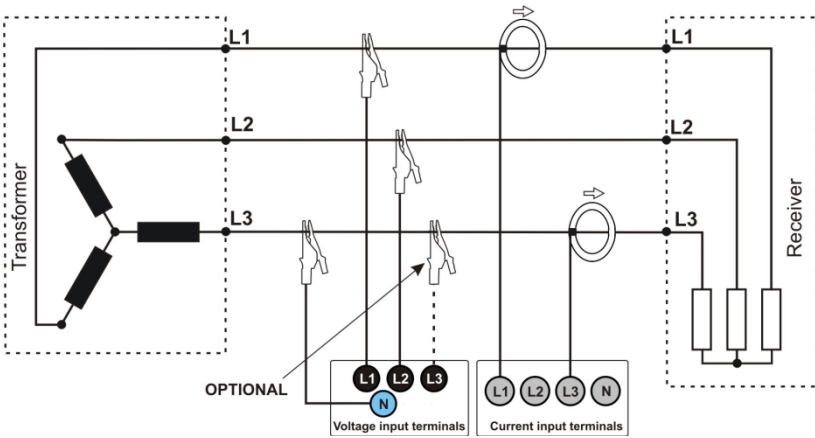

Fig. 11. Wiring diagram – 3-phase wye without neutral conductor (current measurement using Aron method).

2 Operation of the analyzer

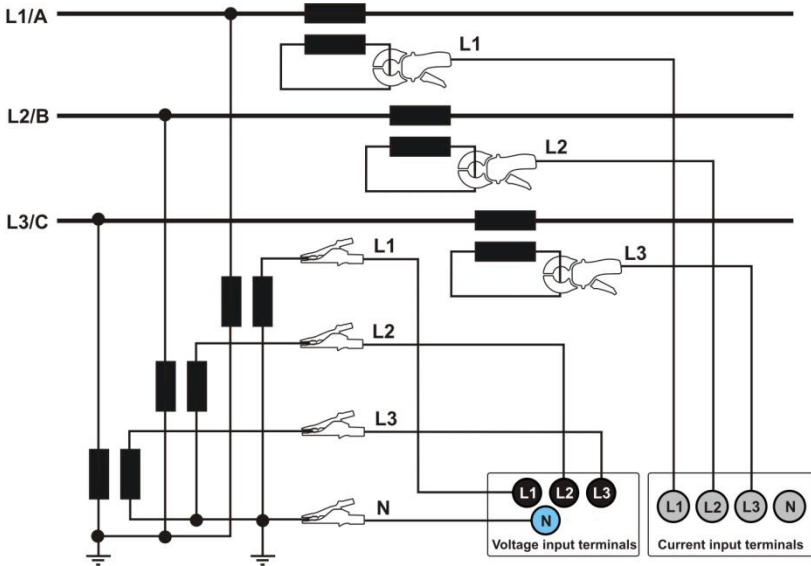

Fig. 12. Wiring diagram – indirect system with transducers – wye configuration.

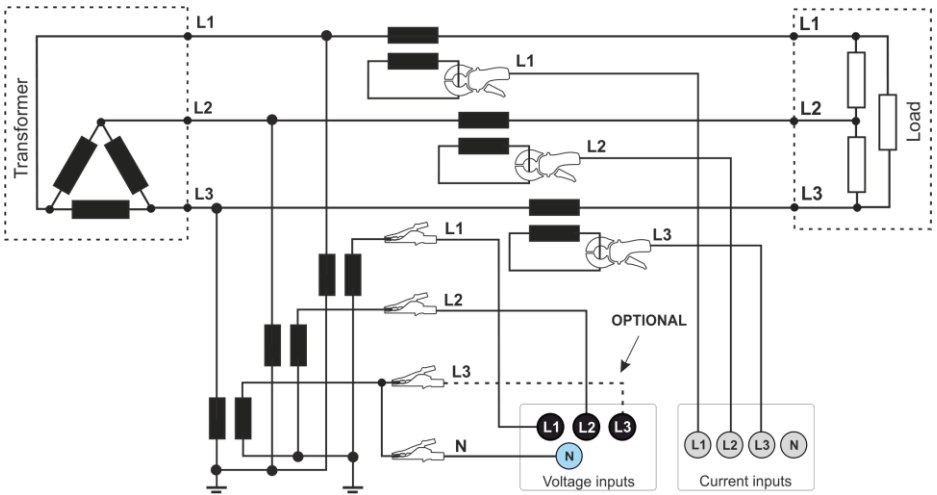



Fig. 13. Wiring diagram – indirect system with transducers – delta configuration.

2.10 Key Lock

Using the PC program, the user may select an option of locking the keypad after starting the process of recording. This solution is designed to protect the analyzer against unauthorized stopping of the recording process.

To unlock the keys, follow these steps:

- press three times in a row  button in steps of 0.5 s and 1 s,
- then press  button within 0.5 s to 1 s,

When buttons are pressed, the user hears the sounds of inactive buttons – after completing the whole sequence the meter emits a double beep.

2.11 Sleep mode

PC software has the feature that can activate the sleep mode. In this mode, when the user starts recording, the meter turns off LEDs after 10 seconds. From this moment the following options are available:

- immediate triggering – after LEDs are turned off, **LOG** LED blinks every 10 s signalling the recording process,
- triggering by event – after LEDs are turned off, **LOG** LED blinks every 30 s in stand-by mode, and when the recording process starts **LOG** LED starts to blink every 10 s,
- scheduled triggering – after LEDs are turned off, **LOG** LED blinks every 30 s in stand-by mode, and when the recording process starts **LOG** LED starts to blink every 10 s.

In addition to the above cases:

- if the user interrupts the recording process by pressing , then LEDs are lit, unless the next recording is triggered,
- if the analyzer finishes the recording process due to the lack of space on the memory card or due to a completed schedule, the LEDs remain off.

Pressing any button (shortly) activates **ON** LED (and possibly other LEDs e.g. **MEM** depending on the state) and activates desired feature (if available).

2.12 Firmware update

Firmware of the analyzer must be regularly updated in order to correct discovered errors or introduce new functionalities. When the firmware is updated, check whether a new version of *Sonel Analysis* (and vice versa) is available, if yes – proceed with the upgrade.

2.12.1 Automatic update

Automatic update (recommended) is carried out with *Sonel Analysis* software. If the user activates option **Check online updates** in the software settings, the software will connect to the update server during startup. If updates are available, they are displayed (with a list of changes) and the user can confirm their download. The check for updates may be also activated manually by entering the menu and selecting **Help → On-line update**. If the firmware update is available and has been downloaded, you can upgrade the firmware of the meter. To do this:

1. Before starting the update, download all the data from the analyzer to a computer (download and save the recorded data on the disk).
2. Connect the analyzer to the mains for battery charging.
3. Connect the analyzer to the computer via a USB cable and establish a connection between the analyzer and the application. Immediately after connecting, *Sonel Analysis* should display

3 "Sonel Analysis" software

a message about the option of updating the firmware (if the user sets in software options "**Check firmware version while connecting**").

4. After confirming the update, wait until the process is completed.
5. **NOTE:** After a successful update, it is necessary to program the analyzer at least once before starting recording, in order to avoid inconsistencies in the recorded data.

2.12.2 Manual update

Manual update requires saving the appropriate firmware file on the memory card and starting the update with the button.

1. Before starting the update, download all the data from the analyzer to a computer (download and save the recorded data on the disk).
2. Connect the analyzer to the mains for battery charging.
3. Download a new firmware from the manufacturer's website *www.sonel.pl*. If the file is compressed, extract file FIRMWARE.PQF.
4. FIRMWARE.PQF file must be saved in the root directory of the microSD card using an external card reader.
5. Insert the card into the analyzer. **ON** LED indicates that the firmware file was recognized and readiness to start the update.
6. Press **START**  button to begin the update. If the **START** button is not pressed within 10 seconds, the update is cancelled. The process progress is indicated by blinking LEDs **ON** and **MEM**.
7. **NOTE:** After a successful update, it is necessary to program the analyzer at least once before starting recording, in order to avoid inconsistencies in the recorded data.

3 "Sonel Analysis" software

Sonel Analysis is an application required to work with PQM-700 analyzer. It enables the user to:

- configure the analyzer,
- read data from the device,
- real-time preview of the mains,
- delete data in the analyzer,
- present data in the tabular form,
- present data in the form of graphs,
- analysing data for compliance with EN 50160 standard (reports), or other user-defined reference conditions,
- independent operation of multiple devices,
- upgrade the software and the device firmware to newer versions.

Detailed manual for *Sonel Analysis* is available in a separate document (also downloadable from the manufacturer's website www.sonel.pl).

4 Design and measurement methods

4.1 Voltage inputs

The voltage input block is shown in Fig. 14. Three phase inputs L1/A, L2/B, L3/C have common reference line, which is the N (neutral) input. Such inputs configuration allows reducing the number of conductors necessary to connect the analyzer to the measured mains. Fig. 14 presents that the power supply circuit of the analyzer is independent of the measuring circuit. The power adapter has a nominal input voltage range 100...415 V AC (140...415 V DC) and has a separate terminals.

The analyzer has one voltage range, with voltage range $\pm 1150V$.

4.2 Current inputs

The analyzer has four independent current inputs with identical parameters. Current transformer (CT) clamps with voltage output in a 1 V standard, or flexible clamps (probes) F-1(A), F-2(A) and F-3(A) can be connected to each input.

A typical situation is using flexible clamps with built-in electronic integrator. However, the PQM-700 allows connecting the Rogowski coil alone to the input and a digital signal integration.

4.2.1 Digital integrator

The PQM-700 uses the solution with digital integration of signal coming directly from the Rogowski coil. Such approach has allowed the elimination of the analog integrator problems connected with the necessity to ensure declared long-term accuracy in difficult measuring environments. The analog integrators must also include the systems protecting the inputs from saturation in case DC voltage is present on the input.

A perfect integrator has an infinite amplification for DC signals which falls with the rate of 20 dB/decade of frequency. The phase shift is fixed over the whole frequency range and equals -90° .

Theoretically infinite amplification for a DC signal, if present on the integrator input, causes the input saturation near the power supply voltage and makes further operation impossible. In practically implemented systems, a solution is applied which limits the amplification for DC to a specified value, and in addition periodically zeroes the output. There are also techniques of active cancellation of DC voltage which involve its measurement and re-applying to the input, but with an opposite sign, which effectively cancels such voltage. There is a term "leaky integrator" which describes an integrator with finite DC gain. An analog leaky integrator is just an integrator featuring a capacitor shunted with a high-value resistor. Such a system is then identical with a low-pass filter of a very low pass frequency.

Digital integrator implementation ensures excellent long-term parameters – the entire procedure is performed by means of calculations, and aging of components, drifts, etc. have been eliminated. However, just like in the analog version, also here we can find the saturation problem and without a suitable counteraction the digital integration may become useless. It should be remembered that both, input amplifiers and analog-to-digital converters, have a given finite and undesirable offset which must be removed prior to integration. The PQM-700 analyzer firmware includes a digital filter which is to remove totally the DC voltage component. The filtered signal is subjected to digital integration. The resultant phase response has excellent properties, and the phase shift for most critical frequencies 50 and 60 Hz is minimal.

Ensuring the least possible phase shift between the voltage and current components is very important for obtaining small power measurement errors. It can be proven that approximate power

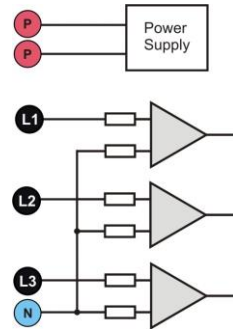

Fig. 14. Voltage Inputs and integrated AC power adapter.

measurement error can be described with the following relationship¹:

$$\text{Power measurement error} \approx \text{phase error (in radians)} \times \tan(\varphi) \times 100 \%$$

where $\tan(\varphi)$ is the tangent of the angle between the fundamental voltage and current components. From the formula, it can be concluded that the measurement errors are increasing as the displacement power factor is decreasing; for example, at the phase error of only 0.1° and $\cos\varphi = 0.5$, the error is 0.3%. Anyway, for the power measurements to be accurate, the phase coincidence of voltage and current circuits must be the highest possible.

4.3 Signal sampling

The signal is sampled simultaneously in all eight channels at the frequency synchronized with the frequency of power supply voltage in the reference channel. This frequency equals 10.24 kHz for the 50 Hz and 60 Hz mains systems.

Each period includes then about 205 samples for 50 Hz systems, and about 170 samples for 60 Hz systems. A 16-bit analog-to-digital converter has been used which ensures 64-fold oversampling.

3-decibel channels attenuation has been specified for frequency of about 12 kHz, and the amplitude error for the 2.4 kHz maximum usable frequency (i.e. the frequency of 40th harmonics in the 60 Hz system) is about 0.3 dB. The phase shift for this frequency is below 15° . Attenuation in the stop band is above 75 dB.

Please note that for correct measurements of phase shift between the voltage harmonics in relation to current harmonics and power of these harmonics, the important factor is not absolute phase shift in relation to the basic frequency, but the phase coincidence of voltage and current circuits. The highest phase difference error for $f = 2.4$ kHz is maximum 15° . Such error is decreasing with the decreasing frequency. Also an additional error caused by used clamps are transducers must be considered when estimating the measurement errors for harmonics power measurements.

4.4 PLL synchronization

The sampling frequency synchronization has been implemented by hardware. After passing through the input circuits, the voltage signal is sent to a band-pass filter which is to reduce the harmonics level and pass only the voltage fundamental component. Then, the signal is sent to the phase locked loop circuits as a reference signal. The PLL system generates the frequency which is a multiple of the reference frequency necessary for clocking of the analog-to-digital converter.

The necessity to use the phase locked loop system results directly from the requirements of the IEC 61000-4-7 standard which describes the methodology and admissible errors during the measurements of harmonic components. The standard requires that the measuring window, being the basis for a single measurement and evaluation of harmonics content, is equal to the duration of 10 periods in the 50 Hz mains systems and 12 periods in the 60 Hz systems. In both cases, it corresponds to about 200 ms. Because the mains frequency can be subject to periodical changes and fluctuations, the window duration might not equal exactly 200 ms and for the 51 Hz frequency will be about 196 ms.

The standard also recommends that before the Fourier transform (to separate the spectral components), the data are not subject to windowing operation. Absence of frequency synchronization and allowing the situation in which the FFT is performed on the samples from not the integer number of periods can lead to spectral leakage. This phenomenon causes that the spectral line of a harmonic blurs also to a few neighboring interharmonic spectral lines which may lead to loss of data about actual level and power of the tested spectral line. The use of Hann weighting window, which reduces the undesirable spectral leakage, has been permitted, but is limited to the situations when the PLL has lost synchronization.

¹ "Current sensing for energy metering", William Koon, Analog Devices, Inc.

The IEC 61000-4-7 defines also the required accuracy of the synchronization block: the time between the sampling pulse rising edge and (M+1)-th pulse (where M is the number of samples in the measuring window) should equal the duration of indicated number of periods in the measuring window (10 or 12) with maximum allowed error of $\pm 0,03\%$. To explain it in simpler terms, let's use the following example. For nominal frequencies the measuring window duration is exactly 200ms. If the first sampling pulse occurs exactly at time $t = 0$, the first sampling pulse of the next measuring window should occur at $t = 200 \pm 0.06$ ms. $\pm 60 \mu\text{s}$ is allowed deviation of the sampling edge. The standard also defines the recommended minimum frequency range at which the above-mentioned synchronization system accuracy should be maintained and specifies it as $\pm 5\%$ of rated frequency that is 47.5...52.5 Hz and 57...63 Hz for 50 Hz and 60 Hz mains, respectively.

The input voltage range for which the PLL system will work correctly is quite another matter. The 61000-4-7 standard does not give here any concrete indications or requirements. The PQM-700 PLL circuit needs L1-N voltage above 10 V for proper operation.

4.5 Frequency measurement

The signal for measurement of 10-second frequency values is taken from the L1 voltage channel. It is the same signal which is used for synchronization of the PLL. The L1 signal is sent to the 2nd order band pass filter which passband has been set to 40...70 Hz. This filter is to reduce the level of harmonic components. Then, a square signal is formed from such filtered waveform. The signal periods number and their duration is counted during the 10-second measuring cycle. 10-second time intervals are determined by the real time clock (every full multiple of 10-second time). The frequency is calculated as a ratio of counted periods to their duration.

4.6 Harmonic components measuring method

The harmonics are measured according to the recommendations given in the IEC 61000-4-7 standard.

The standard specifies the measuring method for individual harmonic components.

The whole process comprises a few stages:

- synchronous sampling (10/12 periods),
- Fast Fourier Transform (FFT),
- grouping.

Fast Fourier Transform is performed on the 10/12-period measuring window (about 200 ms). As a result of FFT, we receive a set of spectral lines from the 0 Hz frequency (DC) to the 40th harmonics (about 2.0 kHz for 50Hz or 2.4 kHz for 60 Hz). The distance between successive spectral lines depends directly on the determined length of measuring window and is about 5 Hz.

As the PQM-700 analyzer collects 2048 samples per measuring window (for 50 Hz and 60 Hz), this fulfills the requirement of Fast Fourier Transform that the number of samples subjected to transformation equals a power of 2.

A very important thing is to maintain a constant synchronization of sampling with the mains. FFT can be performed only on the data which include a multiple of the mains period. This condition must be met in order to minimize a so-called spectral leakage which leads to falsified information about actual spectral lines levels. The PQM-700 meets these requirements because the sampling frequency is stabilized by the phase locked loop (PLL).

Because the sampling frequency can fluctuate over time, the standard provides for grouping together with the harmonics main spectral lines also of the spectral lines in their direct vicinity. The reason is that the components energy can pass partially to neighboring interharmonic components.

There are two grouping methods:

- harmonic group (includes the main spectral line and five or six neighboring interharmonic components on each side),
- harmonic subgroup (includes the main spectral line and one neighboring line on each side).

4 Design and measurement methods

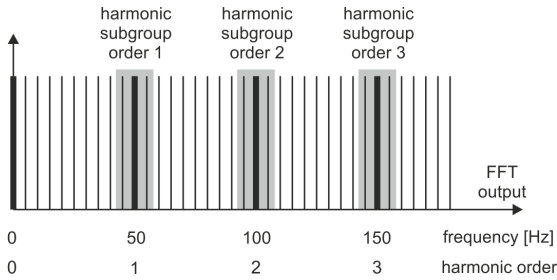

Fig. 15. Determination of harmonic subgroups (50 Hz system).

The IEC 61000-4-30 standard recommends that the harmonic subgroup method is used in power quality analyzers.

Example

In order to calculate the 3rd harmonic component in the 50 Hz system, use the 150 Hz main spectral line and neighboring 145 Hz and 155 Hz lines. The resultant amplitude is calculated with the RMS method.

4.7 Event detection

The PQM-700 analyzer gives a lot of event detection options in the tested mains system. An event is the situation when the parameter value exceeds the user-defined threshold.

The fact of event occurrence is recorded on the memory card as an entry which includes:

- parameter type,
- channel in which the event occurred,
- times of event beginning and end,
- user-defined threshold value,
- parameter extreme value measure during the event,
- parameter average value measure during the event.

Depending on the parameter type, you can set one, two or three thresholds which will be checked by the analyzer. The table below lists all parameters for which the events can be detected, including specification of threshold types.

Tab. 4. Event threshold types for individual parameters

Parameter	Parameter	Interruption	Dip	Swell	Minimum	Maximum
U	RMS voltage	•	•	•		
U _{DC}	DC voltage					•
f	Frequency				•	•
CF U	Voltage crest factor				•	•
u ₂	Voltage negative sequence unbalance					•
P _{st}	Short-term flicker P _{st}					•
P _{lt}	Long-term flicker P _{lt}					•
I	RMS current				•	•
CF I	Current crest factor					
i ₂	Current negative sequence unbalance					•
P	Active power				•	•
Q ₁ , Q _B	Reactive power				•	•
S	Apparent power				•	•
D, S _N	Distortion power				•	•
PF	Power factor				•	•
cosφ	Displacement power factor				•	•
tanφ	tanφ				•	•
E _{P+} , E _{P-}	Active energy (consumed and supplied)					•
E _{Q+} , E _{Q-}	Reactive energy (consumed and supplied)					•
E _S	Apparent energy					•
THD _F U	Voltage THD _F					•
U _{h2..U_{h40}}	Voltage harmonic amplitudes (order n = 2...40)					•
THD _F I	Current THD _F					•
I _{h2..I_{h40}}	Current harmonic amplitudes (order n = 2...40)					•

Some parameters can take positive and negative values. Examples are active power, reactive power, power factor and DC voltage. As the event detection threshold can only be positive, in order to ensure correct detection for above-mentioned parameters, the analyzer compares with the threshold their absolute values.

Example

Event threshold for active power has been set at 10 kW. If the load has a generator character, the active power with correct connection of clamps will be a negative value. If the measured absolute value exceeds the threshold, i.e. 10 kW (for example -11 kW) an event will be recorded – exceeding of the maximum active power.

Two parameter types: RMS voltage and RMS current can generate events for which the user can also have the waveforms record.

The analyzer records the waveforms of active channels (voltage and current) at the event start and end. In both cases, six periods are recorded: two before the start (end) of the event and four after start (end) of the event. The waveforms are recorded in an 8-bit format with 10.24 kHz sampling frequency.

The event information is recorded at its end. In some cases it may happen that event is active when the recording is stopped (i.e. the voltage dip continues). Information about such event is also recorded, but with the following changes:

4 Design and measurement methods

- no event end time,
- extreme value is only for the period until the stop of recording,
- average value is not given,
- only the beginning waveform is available for RMS voltage or current related events.

In order to eliminate repeated event detection when the parameter value oscillates around the threshold value, the analyzer has a functionality of user-defined event detection hysteresis. It is defined in percent in the following manner:

- for RMS voltage events, it is the percent of the nominal voltage range (for example 2% of 230 V, that is 4.6 V),
- for RMS current events, it is the percent of the nominal current range (for example for C-4 clamps and absence of transducers, the 2% hysteresis equals $0.02 \times 1000 \text{ A} = 20 \text{ A}$),
- for remaining parameters, the hysteresis is specified as a percent of maximum threshold (for example, if the maximum threshold for current crest factor has been set to 4.0, the hysteresis will be $0.02 \times 4.0 = 0.08$).

5 Calculation formulas

5.1 One-phase network

One-phase network			
Parameter			Method of calculation
Name	Designation	Unit	
Voltage (True RMS)	U_A	V	$U_A = \sqrt{\frac{1}{M} \sum_{i=1}^M U_i^2}$ where U_i is a subsequent sample of voltage U_{A-N} $M = 2048$ for 50 Hz and 60 Hz
Voltage DC component	U_{ADC}	V	$U_{ADC} = \frac{1}{M} \sum_{i=1}^M U_i$ where U_i is a subsequent sample of voltage U_{A-N} $M = 2048$ for 50 Hz and 60 Hz
Frequency	F	Hz	number of full voltage periods U_{A-N} counted during 10-sec period (clock time) divided by the total duration of full periods
Current (True RMS)	I_A	A	$I_A = \sqrt{\frac{1}{M} \sum_{i=1}^M I_i^2}$ where I_i is subsequent sample of current I_A $M = 2048$ for 50 Hz and 60 Hz
Current constant component	I_{ADC}	A	$I_{ADC} = \frac{1}{M} \sum_{i=1}^M I_i$ where I_i is a subsequent sample of current I_A $M = 2048$ for 50 Hz and 60 Hz
Active power	P	W	$P = \frac{1}{M} \sum_{i=1}^M U_i I_i$ where U_i is a subsequent sample of voltage U_{A-N} I_i is a subsequent sample of current I_A $M = 2048$ for 50 Hz and 60 Hz
Budeanu reactive power	Q_B	var	$Q_B = \sum_{h=1}^{40} U_h I_h \sin \varphi_h$ where U_h is h -th harmonic of voltage U_{A-N} I_h is h -th harmonic of current I_A φ_h is h -th angle between harmonic U_h and I_h
Reactive power of fundamental component	Q_1	var	$Q_1 = U_1 I_1 \sin \varphi_1$ where U_1 is fundamental component of voltage U_{A-N} I_1 is fundamental component of current I_A φ_1 is angle between fundamental components U_1 and I_1
Apparent power	S	VA	$S = U_{ARMS} I_{ARMS}$
Apparent distortion power	S_N	VA	$S_N = \sqrt{S^2 - (U_1 I_1)^2}$
Budeanu distortion power	D_B	var	$D_B = \sqrt{S^2 - P^2 - Q_B^2}$
Power Factor	PF	-	$PF = \frac{P}{S}$ If $PF < 0$, then the load is of a generator type If $PF > 0$, then the load is of a receiver type

5 Calculation formulas

Displacement power factor	$\cos\varphi$ DPF	-	$\cos\varphi = DPF = \cos(\varphi_{U_1} - \varphi_{I_1})$ <p>where φ_{U_1} is an absolute angle of the fundamental component of voltage U_{A-N} φ_{I_1} is an absolute angle of the fundamental component of current I_A</p>
Tangent φ (4-quadrant)	$\tan\varphi_{(L+)}$	-	$\tan\varphi_{(L+)} = \frac{\Delta E_{Q(L+)}}{\Delta E_{P+}}$ <p>where: $\Delta E_{Q(L+)}$ is the increase in reactive energy $E_{Q(L+)}$ (Budeanu/IEEE-1459) in a given averaging period, ΔE_{P+} is the increase in active power taken E_{P+} in a given averaging period</p>
	$\tan\varphi_{(C-)}$	-	$\tan\varphi_{(C-)} = -\frac{\Delta E_{Q(C-)}}{\Delta E_{P+}}$ <p>where: $\Delta E_{Q(C-)}$ is the increase in reactive energy $E_{Q(C-)}$ (Budeanu/IEEE-1459) in a given averaging period, ΔE_{P+} is the increase in active power taken E_{P+} in a given averaging period</p>
	$\tan\varphi_{(L-)}$	-	$\tan\varphi_{(L-)} = \frac{\Delta E_{Q(L-)}}{\Delta E_{P+}}$ <p>where: $\Delta E_{Q(L-)}$ is the increase in reactive energy $E_{Q(L-)}$ (Budeanu/IEEE-1459) in a given averaging period, ΔE_{P+} is the increase in active power taken E_{P+} in a given averaging period</p>
	$\tan\varphi_{(C+)}$	-	$\tan\varphi_{(C+)} = -\frac{\Delta E_{Q(C+)}}{\Delta E_{P+}}$ <p>where: $\Delta E_{Q(C+)}$ is the increase in reactive energy $E_{Q(C+)}$ (Budeanu/IEEE-1459) in a given averaging period, ΔE_{P+} is the increase in active power taken E_{P+} in a given averaging period</p>
Harmonic components of voltage and current	U_{hx} I_{hx}	V A	method of harmonic subgroups according to IEC 61000-4-7 x (harmonic) = 1..40
Total Harmonic Distortion for voltage, referred to the fundamental component	$THDU_F$	-	$THDU_F = \frac{\sqrt{\sum_{h=2}^{40} U_h^2}}{U_1} \times 100\%$ <p>where U_h is h-th harmonic of voltage U_{A-N} U_1 is fundamental component of voltage U_{A-N}</p>
Total Harmonic Distortion for voltage, referred to RMS	$THDU_R$	-	$THDU_R = \frac{\sqrt{\sum_{h=2}^{40} U_h^2}}{U_{ARMS}} \times 100\%$ <p>where U_h is h-th harmonic of voltage U_{A-N}</p>
Total Harmonic Distortion for current, referred to the fundamental component	$THDI_F$	-	$THDI_F = \frac{\sqrt{\sum_{h=2}^{40} I_h^2}}{I_1} \times 100\%$ <p>where I_h is h-th harmonic of current I_A I_1 is fundamental component of current I_A</p>
Total Harmonic Distortion for current, referred to RMS	$THDI_R$	-	$THDI_R = \frac{\sqrt{\sum_{h=2}^{40} I_h^2}}{I_{ARMS}} \times 100\%$ <p>where I_h is h-th harmonic of current I_A</p>
TDD factor	TDD	-	$TDD = \frac{\sqrt{\sum_{h=2}^{40} I_h^2}}{I_L} \times 100\%$ <p>where I_h is the h-th harmonic of current I_A I_L is demand current (in automatic mode I_L is the maximum average value of the fundamental component of current, found in all measured current channels of the entire recording range)</p>

Voltage crest factor	CFU	-	$CFU = \frac{\max U_i }{U_{ARMS}}$ $\max U_i $ Where the operator expresses the highest absolute value of voltage U_{A-N} samples $i = 2048$ for 50 Hz and 60 Hz
Current crest factor	CFI	-	$CFI = \frac{\max I_i }{I_{ARMS}}$ $\max I_i $ Where the operator expresses the highest absolute value of current I_A samples $i = 2048$ for 50 Hz and 60 Hz
Short-term flicker	P_{st}	-	calculated according to IEC 61000-4-15
Long-term flicker	P_{lt}	-	$P_{LT} = \frac{1}{3} \sqrt{\sum_{i=1}^{12} (P_{STi})^3}$ where P_{STi} is subsequent i -th indicator of short-term flicker
Active energy (consumed and supplied)	E_{P+} E_{P-}	Wh	$E_{P+} = \sum_{i=1}^M P_+(i)T(i)$ $P_+(i) = \begin{cases} P(i) & \text{for } P(i) > 0 \\ 0 & \text{for } P(i) \leq 0 \end{cases}$ $E_{P-} = \sum_{i=1}^M P_-(i)T(i)$ $P_-(i) = \begin{cases} P(i) & \text{for } P(i) < 0 \\ 0 & \text{for } P(i) \geq 0 \end{cases}$ where: i is subsequent number of the 10/12-period measurement window $P(i)$ represents active power P calculated in i -th measuring window $T(i)$ represents duration of i -th measuring window (in hours)
Reactive energy (4-quadrant)	$E_{Q(L+)}$ $E_{Q(C-)}$ $E_{Q(L-)}$ $E_{Q(C+)}$	varh	$E_{Q(L+)} = \sum_{i=1}^M Q_{L+}(i)T(i)$ $Q_{L+}(i) = Q(i) \text{ if } Q(i) > 0 \text{ i } P(i) > 0$ $Q_{L+}(i) = 0 \text{ in other cases}$ $E_{Q(C-)} = \sum_{i=1}^M Q_{C-}(i)T(i)$ $Q_{C-}(i) = Q(i) \text{ if } Q(i) > 0 \text{ i } P(i) < 0$ $Q_{C-}(i) = 0 \text{ in other cases}$ $E_{Q(L-)} = \sum_{i=1}^M Q_{L-}(i)T(i)$ $Q_{L-}(i) = Q(i) \text{ if } Q(i) < 0 \text{ i } P(i) < 0$ $Q_{L-}(i) = 0 \text{ in other cases}$ $E_{Q(C+)} = \sum_{i=1}^M Q_{C+}(i)T(i)$ $Q_{C+}(i) = Q(i) \text{ if } Q(i) < 0 \text{ i } P(i) > 0$ $Q_{C+}(i) = 0 \text{ in other cases}$

5 Calculation formulas

			<p>where: i is subsequent number of the 10/12-period measurement window $Q(i)$ represents active power (Budeanu or IEEE1459) calculated in i-th measuring window $P(i)$ represents calculated active power in the i-th measuring window $T(i)$ represents duration of i-th measuring window (in hours)</p>
Apparent energy	E_S	VAh	$E_S = \sum_{i=1}^M S(i)T(i)$ <p>where: i is subsequent number of the 10/12-period measurement window $S(i)$ represents apparent power S calculated in i-th measuring window $T(i)$ represents duration of i-th measuring window (in hours)</p>

5.2 Split-phase network

Split-phase network			
(parameters not mentioned are calculated as for single-phase)			
Parameter			Method of calculation
Name	Designation	Unit	
Total active power	P_{tot}	W	$P_{tot} = P_A + P_B$
Total Budeanu reactive power	Q_{Btot}	var	$Q_{Btot} = Q_{BA} + Q_{BB}$
Total reactive power of fundamental component	Q_{1tot}	var	$Q_{1tot} = Q_{1A} + Q_{1B}$
Total apparent power	S_{tot}	VA	$S_{tot} = S_A + S_B$
Total apparent distortion power	S_{Ntot}	VA	$S_{Ntot} = S_{NA} + S_{NB}$
Total Budeanu distortion power	D_{Btot}	var	$D_{Btot} = D_{BA} + D_{BB}$
Total Power Factor	PF_{tot}	-	$PF_{tot} = \frac{P_{tot}}{S_{tot}}$
Total displacement power factor	$\cos\varphi_{tot}$ DPF_{tot}	-	$\cos\varphi_{tot} = DPF_{tot} = \frac{1}{2}(\cos\varphi_A + \cos\varphi_B)$
Total tangent φ (4-quadrant)	$\tan\varphi_{tot(L+)}$	-	$\tan\varphi_{tot(L+)} = \frac{\Delta E_{Q_{tot(L+)}}}{\Delta E_{P_{tot+}}}$ <p>where: $\Delta E_{Q_{tot(L+)}}$ is the increase in total reactive energy $E_{Q_{tot(L+)}}$ (Budeanu/IEEE-1459) in a given averaging period, $\Delta E_{P_{tot+}}$ is the increase in total active energy $E_{P_{tot+}}$ in a given averaging period</p>
	$\tan\varphi_{tot(C-)}$	-	$\tan\varphi_{tot(C-)} = -\frac{\Delta E_{Q_{tot(C-)}}}{\Delta E_{P_{tot+}}}$ <p>where: $\Delta E_{Q_{tot(C-)}}$ is the increase in total reactive energy $E_{Q_{tot(C-)}}$ (Budeanu/IEEE-1459) in a given averaging period, $\Delta E_{P_{tot+}}$ is the increase in total active energy taken $E_{P_{tot+}}$ in a given averaging period</p>

	$\tan\varphi_{tot(L-)}$	-	$\tan\varphi_{tot(L-)} = \frac{\Delta E_{Q_{tot(L-)}}}{\Delta E_{P_{tot+}}}$ <p>where: $\Delta E_{Q_{tot(L-)}}$ is the increase in total reactive energy $E_{Q_{tot(L-)}}$ (Budeanu/IEEE-1459) in a given averaging period, $\Delta E_{P_{tot+}}$ is the increase in total active energy taken $E_{P_{tot+}}$ in a given averaging period</p>
	$\tan\varphi_{tot(C+)}$	-	$\tan\varphi_{tot(C+)} = -\frac{\Delta E_{Q_{tot(C+)}}}{\Delta E_{P_{tot+}}}$ <p>where: $\Delta E_{Q_{tot(C+)}}$ is the increase in total reactive energy $E_{Q_{tot(C+)}}$ (Budeanu/IEEE-1459) in a given averaging period, $\Delta E_{P_{tot+}}$ is the increase in total active energy taken $E_{P_{tot+}}$ in a given averaging period</p>
Total active energy (consumed and supplied)	$E_{P_{tot+}}$ $E_{P_{tot-}}$	Wh	$E_{P_{tot+}} = \sum_{i=1}^M P_{tot+}(i)T(i)$ $P_{tot+}(i) = \begin{cases} P_{tot}(i) & \text{for } P_{tot}(i) > 0 \\ 0 & \text{for } P_{tot}(i) \leq 0 \end{cases}$ $E_{P_{tot-}} = \sum_{i=1}^M P_{tot-}(i)T(i)$ <p>where: <i>i</i> is subsequent number of the 10/12-period measurement window, $P_{tot}(i)$ represents total active power P_{tot} calculated in <i>i</i>-th measuring window $T(i)$ represents duration of <i>i</i>-th measuring window (in hours)</p>
Total reactive energy (4-quadrant)	$E_{Q_{tot(L+)}}$ $E_{Q_{tot(C-)}}$ $E_{Q_{tot(L-)}}$ $E_{Q_{tot(C+)}}$	varh	$E_{Q_{tot(L+)}} = \sum_{i=1}^M Q_{L+}(i)T(i)$ $Q_{L+}(i) = Q(i) \text{ if } Q(i) > 0 \text{ i } P(i) > 0$ $Q_{L+}(i) = 0 \text{ in other cases}$ $E_{Q_{tot(C-)}} = \sum_{i=1}^M Q_{C-}(i)T(i)$ $Q_{C-}(i) = Q(i) \text{ if } Q(i) > 0 \text{ i } P(i) < 0$ $Q_{C-}(i) = 0 \text{ in other cases}$ $E_{Q_{tot(L-)}} = \sum_{i=1}^M Q_{L-}(i)T(i)$ $Q_{L-}(i) = Q(i) \text{ if } Q(i) < 0 \text{ i } P(i) < 0$ $Q_{L-}(i) = 0 \text{ in other cases}$ $E_{Q_{tot(C+)}} = \sum_{i=1}^M Q_{C+}(i)T(i)$ $Q_{C+}(i) = Q(i) \text{ if } Q(i) < 0 \text{ i } P(i) > 0$ $Q_{C+}(i) = 0 \text{ in other cases}$ <p>where: <i>i</i> is subsequent number of the 10/12-period measurement window, $Q(i)$ represents total reactive power (Budeanu or IEEE1459) calculated in <i>i</i>-th measuring window, $P(i)$ represents total active power calculated in <i>i</i>-th measuring window,</p>

5 Calculation formulas

			$T(i)$ represents duration of i -th measuring window (in hours)
Total apparent energy	E_{Stot}	VAh	$E_{Stot} = \sum_{i=1}^M S_{tot}(i)T(i)$ <p>where: i is subsequent number of the 10/12-period measurement window $S_{tot}(i)$ represents total apparent power S_{tot} calculated in i-th measuring window $T(i)$ represents duration of i-th measuring window (in hours)</p>

5.3 3-phase wye network with N conductor

3-phase wye network with N conductor (parameters not mentioned are calculated as for single-phase)			
Parameter			Method of calculation
Name	Designation	Unit	
Total active power	P_{tot}	W	$P_{tot} = P_A + P_B + P_C$
Total Budeanu reactive power	Q_{Btot}	var	$Q_{Btot} = Q_{BA} + Q_{BB} + Q_{BC}$
Total reactive power acc. to IEEE 1459	Q_{r^+}	var	$Q_{r^+} = 3U_1^+ I_1^+ \sin \varphi_1^+$ <p>where: U_{1^+} is the voltage positive sequence component (of the fundamental component) I_{1^+} is the current positive sequence component (of the fundamental component) φ_{1^+} is the angle between components U_{1^+} and I_{1^+}</p>
Effective apparent power	S_e	VA	$S_e = 3U_e I_e$ <p>where:</p> $U_e = \sqrt{\frac{3(U_A^2 + U_B^2 + U_C^2) + U_{AB}^2 + U_{BC}^2 + U_{CA}^2}{18}}$ $I_e = \sqrt{\frac{I_A^2 + I_B^2 + I_C^2 + I_N^2}{3}}$
Effective apparent distortion power	S_{eN}	VA	$S_{eN} = \sqrt{S_e^2 + S_{e1}^2}$ <p>where:</p> $S_{e1} = 3U_{e1} I_{e1}$ $U_{e1} = \sqrt{\frac{3(U_{A1}^2 + U_{B1}^2 + U_{C1}^2) + U_{AB1}^2 + U_{BC1}^2 + U_{CA1}^2}{18}}$ $I_{e1} = \sqrt{\frac{I_{A1}^2 + I_{B1}^2 + I_{C1}^2 + I_{N1}^2}{3}}$
Total Budeanu distortion power	D_{Btot}	var	$D_{Btot} = D_{BA} + D_{BB} + D_{BC}$
Total Power Factor	PF_{tot}	-	$PF_{tot} = \frac{P_{tot}}{S_e}$

Total displacement power factor	$\cos\varphi_{tot}$ DPF_{tot}	-	$\cos\varphi_{tot} = DPF_{tot} = \frac{1}{3}(\cos\varphi_A + \cos\varphi_B + \cos\varphi_C)$
Total tangent φ (4-quadrant)	$\tan\varphi_{tot(L+)}$ $\tan\varphi_{tot(C-)}$ $\tan\varphi_{tot(L-)}$ $\tan\varphi_{tot(C+)}$	-	calculated as for the split-phase network
Total active energy (consumed and supplied)	E_{P+tot} E_{P-tot}	Wh	formula same as in split-phase system
Total reactive energy (4-quadrant)	$E_{Qtot(L+)}$ $E_{Qtot(C-)}$ $E_{Qtot(L-)}$ $E_{Qtot(C+)}$	varh	calculated as for the split-phase network
Total apparent energy	E_{Stot}	VAh	$E_{Stot} = \sum_{i=1}^M S_e(i)T(i)$ <p>where: <i>i</i> is subsequent number of the 10/12-period measurement window <i>S_e(i)</i> represents the effective apparent power <i>S_e</i>, calculated in <i>i</i>-th measuring window <i>T(i)</i> represents duration of <i>i</i>-th measuring window (in hours)</p>
RMS value of zero voltage sequence	U_0	V	$\underline{U}_0 = \frac{1}{3}(\underline{U}_{A1} + \underline{U}_{B1} + \underline{U}_{C1})$ $U_0 = \text{mag}(\underline{U}_0)$ <p>where \underline{U}_{A1}, \underline{U}_{B1}, \underline{U}_{C1} are vectors of fundamental components of phase voltages U_A, U_B, U_C Operator $\text{mag}()$ indicates vector module</p>
RMS value of positive voltage sequence	U_1	V	$\underline{U}_1 = \frac{1}{3}(\underline{U}_{A1} + a\underline{U}_{B1} + a^2\underline{U}_{C1})$ $U_1 = \text{mag}(\underline{U}_1)$ <p>where \underline{U}_{A1}, \underline{U}_{B1}, \underline{U}_{C1} are vectors of fundamental components of phase voltages U_A, U_B, U_C Operator $\text{mag}()$ indicates vector module</p> $a = 1e^{j120^\circ} = -\frac{1}{2} + \frac{\sqrt{3}}{2}j$ $a^2 = 1e^{j240^\circ} = -\frac{1}{2} - \frac{\sqrt{3}}{2}j$
RMS value of negative voltage sequence	U_2	V	$\underline{U}_2 = \frac{1}{3}(\underline{U}_{A1} + a^2\underline{U}_{B1} + a\underline{U}_{C1})$ $U_2 = \text{mag}(\underline{U}_2)$ <p>where \underline{U}_{A1}, \underline{U}_{B1}, \underline{U}_{C1} are vectors of fundamental components of phase voltages U_A, U_B, U_C Operator $\text{mag}()$ indicates vector module</p> $a = 1e^{j120^\circ} = -\frac{1}{2} + \frac{\sqrt{3}}{2}j$ $a^2 = 1e^{j240^\circ} = -\frac{1}{2} - \frac{\sqrt{3}}{2}j$
Voltage unbalance factor for zero component	u_0	%	$u_0 = \frac{U_0}{U_1} \cdot 100\%$

5 Calculation formulas

Voltage unbalance factor for negative sequence	u_2	%	$u_2 = \frac{U_2}{U_1} \cdot 100\%$
Current zero sequence	I_0	A	$I_0 = \frac{1}{3}(I_{A1} + I_{B1} + I_{C1})$ $I_0 = \text{mag}(I_0)$ <p>where I_{A1}, I_{B1}, I_{C1} are vectors of fundamental components for phase currents I_A, I_B, I_C Operator $\text{mag}()$ indicates vector module</p>
RMS value of positive current sequence	I_1	A	$I_1 = \frac{1}{3}(I_{A1} + aI_{B1} + a^2I_{C1})$ $I_1 = \text{mag}(I_1)$ <p>where I_{A1}, I_{B1}, I_{C1} are vectors of fundamental current components I_A, I_B, I_C Operator $\text{mag}()$ indicates vector module</p>
RMS value of negative current sequence	I_2	A	$I_2 = \frac{1}{3}(I_{A1} + a^2I_{B1} + aI_{C1})$ $I_2 = \text{mag}(I_2)$ <p>where I_{A1}, I_{B1}, I_{C1} are vectors of fundamental components for phase voltages I_A, I_B, I_C Operator $\text{mag}()$ indicates vector module</p>
Current unbalance factor for zero sequence	i_0	%	$i_0 = \frac{I_0}{I_1} \cdot 100\%$
Current unbalance factor for negative sequence	i_2	%	$i_2 = \frac{I_2}{I_1} \cdot 100\%$

5.4 3-phase wye and delta network without neutral conductor

3-phase wye and delta network without neutral conductor

(Parameters: RMS voltage and current, DC components of voltage and current, THD, flicker are calculated as for 1-phase circuits; instead of the phase voltages, phase-to-phase voltages are used. Symmetrical components and unbalance factors are calculated as in 3-phase 4-wire systems.)

Parameter			Method of calculation
Name	Designation	Unit	
Phase-to-phase voltage U_{CA}	U_{CA}	V	$U_{CA} = -(U_{AB} + U_{BC})$
Current I_2 (Aron measuring circuits)	I_2	A	$I_2 = -(I_1 + I_3)$
Total active power	P_{tot}	W	$P_{tot} = \frac{1}{M} \left(\sum_{i=1}^M U_{iAC} I_{iA} + \sum_{i=1}^M U_{iBC} I_{iB} \right)$ <p>where: U_{iAC} is a subsequent sample of voltage U_{A-C} U_{iBC} is a subsequent sample of voltage U_{B-C} I_{iA} is a subsequent sample of current I_A I_{iB} is a subsequent sample of current I_B $M = 2048$ for 50 Hz and 60 Hz</p>
Total apparent power	S_e	VA	$S_e = 3U_e I_e$ <p>where:</p> $U_e = \sqrt{\frac{U_{AB}^2 + U_{BC}^2 + U_{CA}^2}{9}}$ $I_e = \sqrt{\frac{I_A^2 + I_B^2 + I_C^2}{3}}$
Total reactive power (Budeanu and IEEE 1459)	Q_{tot}	var	$Q = N \operatorname{sign} \sqrt{S_e^2 - P^2}$ <p>where <i>sign</i> is equal to 1 or -1. The sign is determined basing on the angle of phase shift between standardized symmetrical components of voltages and currents</p>
Total Budeanu distortion power	D_{Btot}	var	$D_{Btot} = 0$
Effective apparent distortion power	S_{eN}	VA	$S_{eN} = \sqrt{S_e^2 + S_{e1}^2}$ <p>where:</p> $S_{e1} = 3U_{e1} I_{e1}$ $U_{e1} = \sqrt{\frac{U_{AB1}^2 + U_{BC1}^2 + U_{CA1}^2}{9}}$ $I_{e1} = \sqrt{\frac{I_{A1}^2 + I_{B1}^2 + I_{C1}^2}{3}}$
Total Power Factor	PF_{tot}	-	$PF_{tot} = \frac{P_{tot}}{S_e}$

5 Calculation formulas

<p>Active energy (consumed and supplied)</p>	$\begin{matrix} E_{P_{tot+}} \\ E_{P_{tot-}} \end{matrix}$	<p>Wh</p>	$E_{p+tot} = \sum_{i=1}^M P_{+tot}(i)T(i)$ $P_{+tot}(i) = \begin{cases} P_{tot}(i) & \text{for } P_{tot}(i) > 0 \\ 0 & \text{for } P_{tot}(i) \leq 0 \end{cases}$ $E_{p-tot} = \sum_{i=1}^M P_{-tot}(i)T(i)$ $P_{-tot}(i) = \begin{cases} P_{tot}(i) & \text{for } P_{tot}(and) < 0 \\ 0 & \text{for } P_{tot}(i) \geq 0 \end{cases}$ <p>where: <i>i</i> is subsequent number of the 10/12-period measurement window <i>P_{tot}(i)</i> represents total active power <i>P_{tot}</i> calculated in <i>i</i>-th measuring window <i>T(i)</i> represents duration of <i>i</i>-th measuring window (in hours)</p>
<p>Total apparent energy</p>	E_{Stot}	<p>VAh</p>	$E_{Stot} = \sum_{i=1}^M S_e(i)T(i)$ <p>where: <i>i</i>s subsequent number of the 10/12-period measurement window <i>S_e(i)</i> represents the total apparent power <i>S_e</i> calculated in <i>i</i>-th measuring window <i>T(i)</i> represents duration of <i>i</i>-th measuring window (in hours)</p>

5.5 Methods of parameter's averaging

Method of averaging parameter	
Parameter	Averaging method
RMS Voltage	RMS
DC voltage	arithmetic average
Frequency	arithmetic average
Crest factor U, I	arithmetic average
Symmetrical components U, I	RMS
Unbalance factor U, I	calculated from average values of symmetrical components
RMS Current	RMS
Active, Reactive, Apparent and Distortion Power	arithmetic average
Power factor PF	calculated from the averaged power values
cosφ	arithmetic average
tanφ	calculated as the ratio of the reactive energy delta (in the related quadrant) to the active energy delta
THD U, I	calculated as the ratio of the average RMS value of the higher harmonics to the average RMS value of the fundamental component (for THD-F), or the ratio of the average of RMS value of higher harmonics to the average value of RMS value (for THD-R)
Harmonic amplitudes U, I	RMS
The angles between voltage and current harmonics	arithmetic average
Active and reactive power of harmonics	arithmetic average

Note:

RMS average value is calculated according to the formula:

$$RMS = \sqrt{\frac{1}{N} \sum_{i=1}^N x_i^2}$$

The arithmetic average (AVG) is calculated according to the formula:

$$AVG = \frac{1}{N} \sum_{i=1}^N x_i$$

where:

- X_i is subsequent parameter value to be averaged,
- N is the number of values to be averaged.

6 Power Quality - a guide

6.1 Basic Information

The measurement methodology is mostly imposed by the energy quality standards, mainly IEC 61000-4-30. This standard, introducing precise measurement algorithms, ordered analyzers market, allowing customers to easily compare the devices and their results between the analyzers from different manufacturers. Previously, these devices used different algorithms, and often the results from measurements on the same object were completely different when tested with different devices.

The factors behind growing interest in these issues have included wide use of electronic power controllers, DC/DC converters and switched-mode power supplies, energy-saving fluorescent lamps, etc., that is widely understood electrical power conversion. All of these devices had a ten-

dency to significantly deform the supply current waveform.

The design of switched-mode power supplies (widely used in household and industrial applications) is often based on the principle that the mains alternating voltage is first rectified and smoothed with the use of capacitors, meaning that it is converted to direct voltage (DC), and then with a high frequency and efficiency is converted to required output voltage. Such a solution, however, has an undesirable side effect. Smoothing capacitors are recharged by short current pulses at moments when the mains voltage is close to peak value. From power balance rule it is known that if the current is taken only at short intervals, its crest value must be much higher than in case it is taken in a continuous manner. High ratio of current crest value to RMS value (a so-called crest factor) and reduction of power factor (PF) will result in a situation in which in order to obtain a given active power in a receiver (in watts), the power supplier must supply power greater than the receiver active power (this is a so-called apparent power expressed in volt-amperes, VA). Low power factor causes higher load on the transmission cables and higher costs of electricity transfer. Harmonic current components accompanying such parameters cause additional problems. As a result, the electricity suppliers have started to impose financial penalties upon the customers who have not provided sufficiently high power factor.

Among entities that may be potentially interested in power quality analyzers are power utility companies on one hand, (they may use them to control their customers), and on the other hand the power consumers who may use the analyzers to detect and possibly improve the low power factor and solve other problems related to widely understood power quality issues.

The power source quality parameters, as well as the properties of receivers, are described with many various magnitudes and indicators. This section can shed some light on this area.

As already mentioned, the lack of standardization of measurement methods has caused significant differences in values of individual mains parameters calculated with various devices. Efforts of many engineers resulted in IEC 61000-4-30 standard concerning power quality. For the first time, this standard (and related standards) provided very precise methods, mathematical relations and required measurement accuracy for power quality analyzers. Compliance with the standard (in particular, the class A) should be a guarantee of repeatable and almost identical measurement results of the same magnitudes measured with devices from different manufacturers.

6.2 Current measurement

6.2.1 Current transformer clamps (CT) for AC measurements

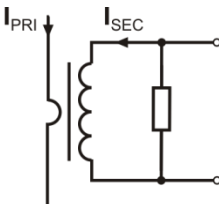

CT Current Transformer is just a transformer converting a large current in primary winding to a smaller current in secondary winding. The jaws of typical current clamp are made of a ferromagnetic material (such as iron) with the secondary winding wound around. The primary winding is a conductor around which the clamp jaws are closed, hence most often it is one single coil. If the 1000-ampere current flows through the tested conductor, in the secondary winding with 1000 coils the current will be only 1 A (if the circuit is closed). In case of clamps with voltage out-

44 **Fig. 16. Current transformer clamp with voltage output.**

put, a shunt resistor is located in the clamps.

Such current transformer has a few characteristic properties. It can be used to measure very large currents, and its power consumption is low. The magnetizing current causes some phase shift (tenth of a degree) which can result in some power measurement error (particularly when the power factor is low). Another disadvantage of this clamp type is also the core saturation phenomenon when very large currents are measured (above the rated range). Core saturation as a result of magnetizing hysteresis leads to significant measurement errors which can be eliminated only by the core demagnetization. The core becomes saturated also when the measured current has a significant DC component. An undeniable disadvantage of such clamp is also its considerable weight.

Despite such drawbacks, the CT clamps are presently the most widely used non-invasive alternating current (AC) measurement method.

The following CT clamps can be used with the PQM-700 analyzers to measure alternating currents:

- C-4(A), rated range 1000 A AC,
- C-6(A), rated range 10 A AC,
- C-7(A), rated range 100 A AC.

6.2.2 AC/DC measurement clamps

There are situations when it is necessary to measure the current DC component. In such case, the clamps must be based on different principle of operation than a traditional current transformer. The clamps in this case use the physical phenomenon known as the Hall effect and include a Hall sensor. In brief: the effect is the production of voltage across an electrical conductor through which the current is flowing and which is placed in a magnetic field. The voltage is transverse to the field induction vector.

The clamps based on this phenomenon can measure the DC and AC current component. The conductor with current located inside the clamps generates a magnetic field which concentrates in an iron core. In the core slot, where both clamp parts are joined, placed is a semiconductor Hall sensor, and its output voltage is amplified by an electronic circuit supplied from a battery.

This clamp type usually has the current zero adjustment knob. To adjust the current zero, close the jaws (no conductor inside) and turn the knob until the DC indication is zero.

In the area of AC/DC measurement clamps, Sonel S.A. offers the C-5(A) clamp with rated range of 1000 A AC / 1400 A DC. This clamp has a voltage output and for 1000 A rated current it gives a 1 V voltage signal (1 mV/A).

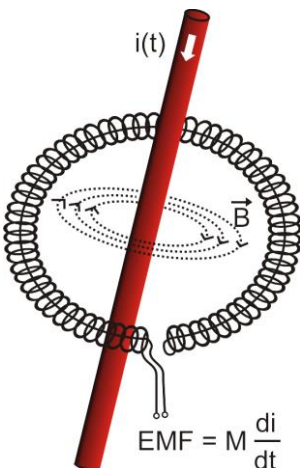

Fig. 17. Rogowski coil.

6.2.3 Flexible current probes

Flexible Current Probes are based on a totally different physical principle than the current transformer. Their principal part is a so-called Rogowski coil, named after German physicist Walter Rogowski. It is an air-core coil wound around a conductor with current. Special design of the coil allows leading out its both ends on the same side, thus facilitating clamp placement around the conductor (the return end is placed inside the coil at its entire length). The current flowing through the measured conductor causes centric magnetic field lines which due to the self-induction phenomenon induce the electromotive force at the end of the coil. This voltage, however, is proportional to the rate of current change in the conductor, and not to the current itself.

In comparison with current transformers, the Rogowski coil has a few indisputable advantages. As it does not have a core, the core saturation effect is eliminated; thus being a perfect instrument to measure large currents. Such coil has also an excellent linearity and a wide pass band, much wider than a current transformer, and its weight is much smaller.

However, until recently the wider expansion of flexible clamps in the current measurement area was difficult. There are some factors which hinder practical implementation of a measurement system with a Rogowski coil. One of them is a very low voltage level which is induced on the clamps (it depends on geometrical dimensions of the coil). For example, the output voltage for the 50 Hz frequency of the F-series flexible probes (to be used with PQM-700) is about 45 $\mu\text{V/A}$. Such low voltages require the use of precise and low-noise amplifiers which of course increase the costs.

Because the output voltage is proportional to the current derivative, it is necessary to use an integrating circuit; generally, the flexible probes comprise a Rogowski coil and an analog integrator circuit (characteristic battery-powered module). On the integrator output available is the voltage signal proportional to measured current and suitably scaled (for example 1 mV/A).

Another problem connected with the Rogowski coil is its sensitivity to external magnetic fields. A perfect coil should be sensitive only to the fields closed within its area and should totally suppress external magnetic fields. But this is a very difficult task. The only way to obtain such properties is very precise manufacture of the coil, with perfectly homogenous windings and impedance as low as possible. It is the high precision which causes a relatively high price of such probe.

The PQM-700 analyzer can be used with the following flexible probes from Sonel S.A.:

- F-1(A), with coil circumference 120 cm,
- F-2(A), with coil circumference 80 cm,
- F-3(A), with coil circumference 45 cm.

All these probes have identical electrical parameters. The peak current which can be measured after connecting to PQM-700 is about 10 kA (the limitation is due to the properties of the input channels, and not the probe itself).

6.3 Flicker

In terms of power quality, flicker means a periodical changes of the luminous intensity as a result of fluctuations of voltage supplied to light bulbs.

The flicker measurement function appeared in the power quality analyzers when it turned out that this phenomenon causes a deteriorated well-being, annoyance, sometimes headache, etc. The luminous intensity fluctuations must have a specified frequency, they may not be too slow as then human iris can adapt to changed lighting, and they may not be too fast because the filament inertia offsets these fluctuations almost totally.

The tests have proved that maximum arduousness occurs at the frequency of about 9 changes per second. The most sensitive light sources are traditional incandescent bulbs with tungsten filament. Halogen bulbs, which filaments have much higher temperature, have also much higher inertia which reduces the perceived brightness changes. Fluorescent lamps have the best flicker "resistance", as due to their some specific properties they stabilize the current flowing through the lamp during the voltage changes, and thus reduce the fluctuations.

Flicker is measured in so-called perceptibility units, and there are two types of flicker: short-term P_{ST} which is determined once every 10 minutes, and long-term P_{LT} which is calculated on the basis of 12 consecutive P_{ST} values, i.e. every 2 hours. Long measurement time results directly from slow-changing character of this phenomenon – in order to collect a reliable data sample, the measurement must be long. P_{ST} equal to 1 is considered a value on the border of annoyance – certainly sensitivity to flicker is different in different people; this threshold has been adopted after tests carried out on a representative group of people.

What causes flicker? Most frequently, the reason is the voltage drop as a result of connecting and disconnecting large loads and some level of flicker is present in the majority of mains systems. Disregarding the unfavorable effect on humans described above, flicker does not need to be – and usually is not – a symptom of malfunctioning of our installation. However, if a rather abrupt

and unexplainable flicker level increase is observed in the mains (increase of P_{ST} and P_{LT}), this should not be ignored under any circumstances. It may turn out that the flicker is caused by un-sure connections in the installation – increased voltage drops on connections in the distribution panel (for example) will result in higher voltage fluctuations on the receivers, such as light bulbs. The voltage drops on connections also cause their heating, and finally sparking and possibly a fire. Periodical mains tests and described symptoms can turn our attention and help find the source of hazard.

6.4 Power measurement

Power is one of the most important parameters defining the properties of electrical circuits. The basic magnitude used for financial settlements between the supplier and the consumer is electric energy which is the power multiplied by time.

A few different power types can be found in electrical engineering:

- active power, designated as P and measured in watts,
- reactive power, designated as Q , unit is var,
- apparent power, S , unit is VA.

These three types of power are the most known, but there are also other types.

At school we are taught that these three power types make up a so-called power triangle which properties are expressed by the following equation:

$$P^2 + Q^2 = S^2$$

This equation is however correct only for systems with sinusoidal voltage and current waveforms.

Before a more detailed discussion about the power measurement, individual types of power should be defined.

6.4.1 Active power

Active power P is a magnitude with precise physical meaning and it expresses the ability of a system to perform a given work. It is the power most desired by the energy consumers and it is for this supplied power that the consumer pays the supplier in a given settlement period (the problem of fees for additional reactive power is discussed separately – see below). It is the active power (and consequently, the active energy) which is measured by electric energy meters in each household.

Basic formula to calculate the active power is as follows:

$$P = \frac{1}{T} \int_t^{t+T} u(t)i(t)dt$$

where: $u(t)$ – instantaneous voltage value, $i(t)$ - instantaneous current value, T – period for which the power is calculated.

In sinusoidal systems, the active power can be calculated as:

$$P = UI\cos\varphi$$

where: U is RMS voltage, I is RMS current, and φ is the phase shift angle between the voltage and the current.

The PQM-700 analyzer calculates the active power directly from the integral formula, using sampled voltage and current waveforms:

$$P = \frac{1}{M} \sum_{i=1}^M U_i I_i$$

where M is a number of samples in the 10/12-period measuring window (2048 for the 50 Hz and 60 Hz system), U_i and I_i are successive voltage and current samples.

6.4.2 Reactive power

The most popular formula for reactive power is also correct only for one-phase circuits with sinusoidal voltage and current waveforms:

$$Q = UI \sin \varphi$$

Interpretation of this power in such systems is as follows: it is an amplitude of AC component of instantaneous power on the source terminals. Existence of a non-zero value of this power indicates a bidirectional and oscillating energy flow between the source and the receiver.

Let us imagine a one-phase system with sinusoidal voltage source which load is a RC circuit. As under such conditions, the elements' behavior is linear, the source current waveform will be sinusoidal, but due to the properties of capacitor it will be shifted in relation to source voltage. In such a system, reactive power Q will be non-zero and can be interpreted as an amplitude of energy oscillation which alternately is collected in the capacitor and returned to the source. Capacitor active power equals zero.

However, it turns out the energy oscillation seems only an effect, and that it appears in particular cases of circuits with sinusoidal current and voltage waveforms, and is not the cause of reactive power. Research in this area has shown that reactive power occurs also in circuits without any energy oscillation. This statement may surprise many engineers. In latest publications on power theory, the only physical phenomenon mentioned which always accompanies appearance of reactive power is phase shift between current and voltage.

The reactive power formula given above is correct only for one-phase sinusoidal circuits. The question thus arises: how do we calculate the reactive power in non-sinusoidal systems? This question opens a proverbial Pandora's box among electrical engineers. It turns out that the reactive power definition in real systems (and not only those idealized) has been subject to controversy and now (2009) we do not have one, generally accepted definition of reactive power in systems with non-sinusoidal voltage and current waveforms, not to mention even unbalanced three-phase systems. The IEEE (Institute of *Electrical* and Electronics Engineers) 1459-2000 standard (from 2000) does not give a formula for total reactive power for non-sinusoidal three-phase systems – as three basic types of power the standard mentions are active power, apparent power and – attention – nonactive power designated as N . Reactive power has been limited only to the fundamental component and designated Q_1 .

This standard is the last document of this type issued by recognized organization which was to put the power definition issues in order. It was even more necessary as the voices had been appearing in scientific circles for many years that the power definitions used so far may give erroneous results. Most of all, the controversies related to the definition of reactive and apparent power (and also distortion power – see below) in one- and three-phase systems with non-sinusoidal current and voltage waveforms.

In 1987, professor L.S. Czarnecki proved that the widely used definition of reactive power by Budeanu was wrong. This definition is still taught in some technical schools and it was proposed by professor Budeanu in 1927. The formula is as follows:

$$Q_B = \sum_{n=0}^{\infty} U_n I_n \sin \varphi_n$$

where U_n and I_n are voltage and current harmonics of order n , and φ_n are angles between these

components.

As, after this magnitude has been introduced, the known power triangle equation was not met for circuits with non-sinusoidal waveforms, Budeanu introduced a new magnitude called the *distortion power*:

$$D_B = \sqrt{S^2 - (P^2 + Q_B^2)}$$

Distortion power was to represent in the system the power appearing due to distorted voltage and current waveforms.

For years, reactive power had been associated with energy oscillations between the source and the load. The formula indicates that according to Budeanu's definition, the reactive power is a sum of reactive power of individual harmonics. Due to the $\sin\varphi$ factor, such components can be positive or negative, depending on the angle between the harmonics of voltage and current. Hence, a situation is possible when total reactive power Q_B will be zero at non-zero harmonic components. Observation that at non-zero components, total reactive power can – according to this definition – be zero is a key to a deeper analysis which finally allowed proving that in some situations Q_B can give quite surprising results. The research has questioned the general belief that there is a relation between energy oscillations and Budeanu reactive power Q_B . One can give examples of circuits in which despite oscillating character of instantaneous power waveform, reactive power according to Budeanu is zero. Over the years, the scientists have not been able to connect any physical phenomenon to the reactive power according to this definition.

Such doubts about the correctness of this definition of course also cast shadow on the related *distortion power* D_B . The scientists have started to look for answers to the question whether the distortion power D_B really is the measure of distorted waveforms in non-sinusoidal circuits. The distortion is a situation in which the voltage waveform cannot be “put” on the current waveform with two operations: change of amplitude and shift in time. In other words, if the following condition is met:

$$u(t) = Ai(t - \tau)$$

the voltage is not distorted in relation to the current. In case of sinusoidal voltage and load which is any combination of RLC elements, this condition is always met (for sinusoidal waveforms, these elements maintain linearity). However, when the voltage is distorted, the RLC load does not ensure absence of current distortion in relation to voltage any more, and the load is no longer linear – it is necessary to meet some additional conditions (module and phase of load impedance changing with frequency).

And then, is really D_B a measure of such distortion? Unfortunately, also in this case the Budeanu's power theory fails. It has been proven that the *distortion power* can be equal to zero in a situation when voltage is distorted in relation to current waveform, and vice versa, the *distortion power* can be non-zero at total absence of distortion.

Practical aspect of this power theory which relates to improvement of power factor in systems with reactive power was to be the feature to take the most advantage of correct definitions of reactive power. The compensation attempts based on the Budeanu reactive power and related distortion power fell through. These magnitudes did not allow even a correct calculation of correction capacitance which gives the maximum power factor. Sometimes, such attempts ended even with additional deterioration of power factor.

How come, then, that the Budeanu's power theory has become so popular? There may be several reasons. Firstly, engineers got accustomed to old definitions and the curricula in schools have not been changed for years. This factor is often underestimated, though as a form of justification it can be said that this theory had not been refuted for 60 years. Secondly, in the 1920s there were no measuring instruments which could give insight in individual voltage and current harmonic components and it was difficult to verify new theories. Thirdly, distorted voltage and current waveforms (i.e. with high harmonics contents) are a result of revolution in electrical power

engineering which did not start before the second part of the last century. Thyristors, controlled rectifiers, converters, etc. began to be widely used. All these caused very large current distortion in the mains, and consequently increased harmonic distortion. Only then, were the deficiencies of the Budeanu's theory felt. Finally, fourthly, the scientific circles related to power utilities were aware of the fact that industrial plants had invested a fortune in the measuring infrastructure (energy meters). Each change in this respect could bring about huge financial consequences.

However, slow changes became visible in the views of electrical engineers. With time, as non-linear loads were more and more frequent and the waveforms more and more distorted, the limitations of used formulas could no longer be tolerated.

A very significant event was the 2000 publication by IEEE of the standard 1459 called "Definitions for the Measurement of Electric Power Quantities Under Sinusoidal, Non-Sinusoidal, Balanced, or Unbalanced Conditions". For the first time, Budeanu's definition of reactive power has been listed as not recommended which should not be used in new reactive power and energy meters. Many magnitudes have been also divided into the part related to the current and voltage fundamental component (first harmonics) and the part related to remaining higher harmonics. In most cases, it is recognized that the usable part of energy is transmitted by the 50/60Hz components, with much smaller (and often harmful) participation of higher harmonics.

The standard also introduced a new magnitude – *nonactive power* N which represents all nonactive components of power:

$$N = \sqrt{S^2 - P^2}$$

Reactive power is one of the components of nonactive power N . In one-phase systems with sinusoidal voltage and current waveforms, N equals Q ; hence the nonactive power does not have any other components. In three-phase systems, this is true only for symmetrical sinusoidal systems with a balanced purely resistive load.

Other nonactive power components are related to concrete physical phenomena. According to the professor Czarneci's theory, which is one of the best in explaining the physical phenomena in three-phase systems, the power equation in such systems is as follows:

$$S^2 = P^2 + D_s^2 + Q^2 + D_u^2$$

D_s is the scattered power which appears in the system as a result of changing load conductance with frequency. Hence, presence of reactive elements in the system may cause the scattered power.

In this equation, reactive power Q appears when there is a phase shift between the voltage and current harmonics.

D_u means the unbalanced power which is a measure of unbalance of a three-phase receiver. This component explains the situation in which an unbalanced three-phase load of a purely resistive character results in the power factor less than one. Such load does not have the reactive power Q , and still the results from the power triangle S , P , Q are totally different (the Budeanu's power theory with its distortion power could not explain this situation either – in a purely resistive load, the distortion power D_B equals zero).

An attempt to connect the IEEE 1459-2000 standard with the Czarneci's power theory leads to the conclusion that nonactive power conceals at least three separate physical phenomena which influence the reduced effectiveness of energy transmission from the source to the receiver, i.e. reduction of the power factor.

$$PF = \frac{P}{S_e} = \frac{P}{\sqrt{P^2 + D_s^2 + Q^2 + D_u^2}}$$

In the IEEE 1459-2000 standard, reactive power known as Q has been limited to the funda-

mental component, for both one-phase and three-phase systems:

$$Q_1 = U_1 I_1 \sin \varphi_1$$

In three-phase systems, only the positive sequence component is taken into consideration:

$$Q_1^+ = 3U_1^+ I_1^+ \sin \varphi_1^+$$

Correct measurement of this power requires the same phase rotation sequence (i.e. phase L2 delayed by 120° in relation to L1, phase L3 delayed by 240° in relation to L1).

The term of positive sequence component will be discussed in more detail in the section devoted to unbalance.

The value of reactive power of the fundamental component is the main value which allows estimating the size of capacitor to improve the displacement power factor (DPF), that is the displacement of the voltage fundamental components in relation to the current fundamental component (i.e. compensator of the reactive power of the fundamental component).

6.4.3 Reactive power and three-wire systems

Correct reactive power measurement is impossible in unbalanced receivers connected according to the three-wire system (delta and wye systems without the N conductor). Such statement may come as a surprise for many people.

The receiver can be treated as a “black box” with only 3 terminals available. We cannot determine its internal structure. In order to calculate the reactive power, we need to know the phase shift angle between the voltage and the current at each leg of such receiver. Unfortunately, we do not know this angle. In the delta-type receiver we know the voltages on individual impedances, but we do not know the current; in such systems, the phase-to-phase voltages and line currents are measured. Each line current is a sum of two phase currents. In the wye without N-type receivers, we know the currents flowing through impedance, but we do not know the voltages (each phase-to-phase voltage is a sum of two phase-to-neutral voltages).

We need to take account of the fact that at given voltage values at terminals and currents flowing into such “black box”, there is an infinite number of variants of receiver internal structure which will give us identical measurement results of voltage and current values visible outside the black box.

Then, how is it possible that there are reactive power meters intended for measurements in three-wire systems and the mains analyzers which allow the reactive power measurement under such circumstances?

In both cases, the manufacturers use the trick which involves an artificial creation of a reference point (virtual neutral terminal N). Such point can be created very easily by connecting to the terminals of our black box a wye-connected system of three resistors of the same value.

In no case should a measuring instrument mislead the user, and such approximation can be allowed only after a clear reservation that the indicated value is not a result of actual measurement, but only an approximated value.

6.4.4 Reactive power and reactive energy meters

Reactive energy meters are devices unknown to the household users who for settlements with energy suppliers use the meters of active energy expressed in Wh or kWh. Household users are in a comfortable situation – they pay only for usable energy and do not have to think what the power factor is in their installations.

In contrast to the first group, the industrial consumers are obliged in their contracts and sometimes under pain of financial penalties to keep the power factor at an appropriate level.

The EN 50160 standard gives some guidelines for the power quality requirements, and defines the quality parameters which should be met by energy supplier. Among these parameters are, among others, mains frequency, RMS voltage, total harmonic distortion (THD) and allowed levels of individual voltage harmonics. Besides EN 50160 requirements there is often an addition-

al condition: the supplier does not need to comply with those requirements if an energy consumer does not ensure the $\tan\phi$ factor below some threshold (agreed value which can be changed in the contract between the energy supplier and consumer, i.e. 0.4) and/or exceeds the agreed level of consumed active energy.

The $\tan\phi$ is defined as a ratio of measured reactive energy to the active energy in a settlement period. Going back for a while to the power triangle in sinusoidal systems, we can see that the tangent of the phase shift angle between the voltage and the current is equal to the ratio of reactive power Q to active power P. Consequently, the requirement to maintain the $\tan\phi$ below 0.4 means nothing else but only that maximum level of measured reactive energy may not exceed 0.4 of the measured active energy. Each consumption of reactive energy above this level is subject to additional fees.

Does the knowledge of $\tan\phi$ calculated in this manner give both interested parties an actual view of energy transmission effectiveness? Have we not mentioned before that the reactive power is only one of the nonactive power components which influence the power factor reduction?

Indeed, it seems that instead of $\tan\phi$ we should use the power factor PF which takes into account also other issues.

Unfortunately, if the present regulations leave no choice, than the correct reactive power measurement seems a key matter. Now, a question should be asked whether the reactive energy meters ensure correct readings in the light of the controversies described above. And what do such widely used meters really measure?

One can attempt to look for answers to these questions is the standard on such meters - IEC 62053-23. Unfortunately, to our disappointment, we will not find there any reference to measurements in non-sinusoidal conditions – the calculation formulas relate to sinusoidal conditions (we can read in the standard that due to “practical” reasons, non-sinusoidal waveforms have been excluded). The standard does not give any measurement criteria which would allow checking the meter properties at distorted voltage and current waveforms. As a surprise comes also the fact that the older standard IEC 61268 (already withdrawn) defined the test which involved checking the measurement accuracy at 10% of the third current harmonic.

The present situation leaves the choice of measuring method to the meters designers, which unfortunately leads to significant differences in reactive energy indications in the presence of high harmonic distortion level.

Older, electromechanical meters have characteristics similar to that of a low-pass filter – higher harmonics are attenuated in such meters and the reactive power measurement in the presence of harmonics is very close to the value of reactive power of the fundamental component.

Electronic meters which are more and more popular can perform the measurement with various methods. For example, they can measure active and apparent power, and then calculate the reactive power from the power triangle (square root from the sum of both such powers squared). In reality, in the view of the IEEE 1459-2000 standard, they measure the nonactive power, not the reactive power. Another manufacturer may use the method with voltage waveform shift by 90° , which gives a result close to the reactive power of the fundamental component.

The higher the harmonics content, the higher difference in readings, and of course, as a consequence, other fees for measured energy.

As it has been signaled before, the reactive power measurement in unbalanced three-wire systems with traditional meters is subject to an additional error caused by creation of a virtual zero inside the meter which has little to do with actual zero of the receiver.

On top of that, the manufacturers usually do not give any information about the applied measuring method.

One can only wait impatiently for the next version of the standard, which – let’s hope – will define the measuring and testing methods much more precisely, also for non-sinusoidal conditions.

6.4.5 4-quadrant reactive energy measurement

In the power sector, in many situations the reactive energy is divided into four separate components, each of which is counted separately. This division into so-called quadrants is based on the signs of active and reactive power as shown in Fig. 18.

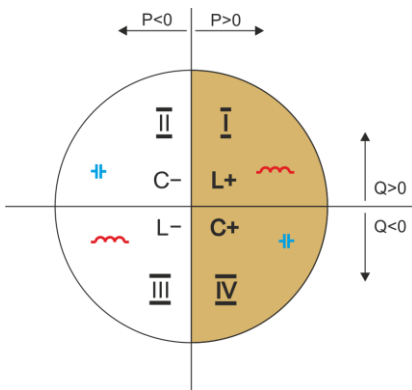

Fig. 18. Four-quadrant division of power and energy flow.

- quadrant I (marked as "L+"): active power is positive (receiving of active energy), reactive power is positive (receiving of reactive power). In such conditions, the nature of the load is inductive.
- quadrant II (marked as "C-"): active power is negative (delivering of active energy), reactive power is positive (receiving of reactive power). The nature of the load is capacitive.
- quadrant III (marked as "L-"): active power is negative (delivering of active energy), reactive power is negative (delivering of reactive energy). In such conditions, the nature of the load is inductive.
- quadrant IV (marked as "C+"): active power is positive (receiving of active energy), reactive power is negative (delivering of reactive power). The nature of the load is capacitive.

Plus and minus signs in marking quadrants indicate the sign of active power.

Presented division allows the construction of reactive energy meters, which increase their state only when the energy flow takes place in a given quadrant. This also means that at a given moment, only one of the counters can increase its status.

In typical case of supplying the energy to a receiver, the operation takes place in two quadrants: I (L+) and IV (C+). Moreover, in these two quadrants the tangents φ ratio is monitored for customers connected to MV and LV networks in some countries. The four-quadrant $\tan\varphi$ coefficients are determined on the basis of recorded appropriate energy intakes:

$$\tan\varphi_{(L+)} = \frac{\Delta E_{Q(L+)}}{\Delta E_{P+}}$$

$$\tan\varphi_{(C+)} = \frac{\Delta E_{Q(C+)}}{\Delta E_{P+}}$$

If the convention is used, assuming all energy meters have a positive sign, the calculated values of tangents are complemented with a character resulting from the character of active and reactive power in a given quadrant. Thus, the sign of $\tan\varphi_{(L+)}$ is always positive, while in case of $\tan\varphi_{(C+)}$ it is always negative.

The calculated values of tangents may be the basis to calculate any penalties for reactive power consumption above the contracted level. In case of quadrant I (L+), a typical limit value above which fees are charged is 0.4. Often, for quadrant IV (C+) any reactive power consumption

is the basis for calculating fines. This also results in practical conclusion that the most profitable (for consumer) is operation in the first quadrant (L+) in the range of $\tan\varphi(L_+)$ between 0 and 0.4.

6.4.6 Apparent power

Apparent power S is expressed as the product of RMS voltage and RMS current:

$$S = UI$$

As such, the apparent power does not have a physical interpretation; it is used during designing of transmission equipment. In terms of value, it is equal to maximum active power which can be supplied to a load at given RMS voltage and current. Thus, the apparent power defines the maximum capacity of the source to supply usable energy to the receiver.

The measure of effective use of supplied power by the receiver is the power factor, which is the ratio of active power to apparent power.

In sinusoidal systems:

$$PF = \frac{P}{S} = \frac{UI\cos\varphi}{UI} = \cos\varphi$$

In non-sinusoidal systems such simplification is however not allowed, and the power factor is calculated on the basis of actual ratio of active power and apparent power.

$$PF = \frac{P}{S}$$

In one-phase systems, the apparent power is calculated as shown in the formula above and there are no surprises. However, it turns out that in three-phase systems calculation of this power is equally difficult as calculation of reactive power. Of course, this is related to actual systems with non-sinusoidal waveforms which additionally can be unbalanced.

The tests have shown that the formulas used so far can give erroneous results if the system is unbalanced. As apparent power is a conventional magnitude and does not have a physical interpretation, determination which of proposed apparent power definitions is correct could be difficult. Yet, the attempts have been made based on the observation that the apparent power is closely related to the transmission losses and the power factor. Knowing the transmission losses and the power factor, one can indirectly specify a correct definition of apparent power.

The definitions which have been used so far include arithmetic apparent power and vector apparent power. The test have shown however that neither the arithmetic definition nor the vector definition give correct value of the power factor. The only definition which did not fail in such a situation, was the definition proposed as early as in 1922 by German physicist F. Buchholz:

$$S_e = 3U_e I_e$$

It is based on RMS current and voltage, and the power is called an effective apparent power (hence, the index "e" in designations in three-phase systems). Those effective voltage and current values are such theoretical values which represent voltage and current in an energetically equivalent three-phase balanced system. Consequently, the key issue is to determine the U_e and I_e .

The IEEE 1459 standard gives the following formulas. In three-wire systems:

$$I_e = \sqrt{\frac{I_a^2 + I_b^2 + I_c^2}{3}}$$

$$U_e = \sqrt{\frac{U_{ab}^2 + U_{bc}^2 + U_{ca}^2}{9}}$$

In four-wire systems:

$$I_e = \sqrt{\frac{I_a^2 + I_b^2 + I_c^2 + I_n^2}{3}}$$

$$U_e = \sqrt{\frac{3(U_a^2 + U_b^2 + U_c^2) + U_{ab}^2 + U_{bc}^2 + U_{ca}^2}{18}}$$

where I_a , I_b , I_c , are RMS currents for individual phases (line or phase), I_n is the RMS current in neutral conductor, U_a , U_b , U_c are RMS phase-to-neutral voltages, and U_{ab} , U_{bc} , U_{ca} are RMS phase-to-phase voltages.

S_e calculated in this manner includes both the power losses in the neutral conductor (in four-wire systems) and the effect of unbalance.

6.4.7 Distortion power D_B and effective nonfundamental apparent power S_{eN}

During the discussion on reactive power, it was proved that the distortion power according to Budeanu cannot be used at large voltage and current distortions and three-phase systems unbalance (a paradox of distortion power which is not a measure of actual distortion). Despite this fact, however, this power is often used by energy quality specialists and manufacturers of systems for reactive power compensation.

It must be clearly said that this parameter has given relatively good results only in conditions of slight distortion of voltage and current waveforms.

The IEEE 1459-2000 standard lists this definition of power, however just like in case of Budeanu reactive power, it has a non-removable defect and it is recommended to discard it entirely. Instead of D_B , another value has been proposed which is a much better characteristics of total distortion power in a system - nonfundamental apparent power S_{eN} . The S_{eN} power allows a quick estimation whether a load works in conditions of small or large harmonic distortion; it is also a basis for estimating the static values and active filters or compensators.

$$S_{eN} = \sqrt{S_e^2 - S_{e1}^2}$$

where:

$$S_{e1} = 3I_{e1}U_{e1}$$

Effective current and effective voltage of the fundamental component (I_{ef} and U_{ef} respectively) are calculated similarly to I_e and U_e , but instead of RMS phase-to-neutral or phase-to-phase voltages, the effective voltages of fundamental components are substituted:

$$S_N = \sqrt{S^2 - (U_1 I_1)^2}$$

where U_1 and I_1 are effective values of fundamental components of phase-to-neutral voltage and current.

6.4.8 Power factor

True Power Factor or Power Factor (TPF or PF) is the value which takes into account also the

6 Power Quality - a guide

presence of higher harmonics. For sinusoidal systems, it is equal to Displacement Power Factor (DPF), popular $\cos\varphi$.

Hence, DPF is a measure of phase shift between the fundamental voltage and current components:

$$DPF = \frac{P_1}{S_1} = \frac{U_1 I_1 \cos\varphi_{U_1 I_1}}{U_1 I_1} = \cos\varphi_{U_1 I_1}$$

The general formula for True Power Factor is:

$$PF = \frac{P}{S}$$

In case of a purely resistive load (in a one-phase system), the apparent power is equal to active power (in terms of value), and reactive power equals zero, so such load fully uses the energy potential of the source and the power factor is 1. Appearance of reactive component inevitably leads to reduction of energy transmission effectiveness – the active power is then less than apparent power, and the reactive power is increasing.

In three-phase systems, the power factor reduction is also influenced by receiver unbalance (see discussion on reactive power). In such systems, correct power factor value is obtained using the effective apparent power S_e that is the value defined, among others, in the IEEE 1459-2000 standard.

6.5 Harmonics

Decomposition of periodic signal into harmonic components is a very popular mathematical operation based on Fourier's theorem which says that any periodic signal can be represented as a sum of sinusoidal components with frequencies equal to multiples of basic frequency of such signal. Time-domain signal can be subjected to Fast Fourier Transform (FFT) to receive amplitudes and phases of harmonic components in the frequency domain.

In a perfect situation, voltage is generated in a generator which at output gives a pure sinusoidal 50/60 Hz waveform (absence of any higher harmonics). If the receiver is a linear system, then also current in such situation is a pure sinusoidal waveform. In real systems, voltage and current waveforms can be distorted, hence in addition to the fundamental component there must be harmonics of higher orders.

Why is the presence of higher harmonics in the system not desirable?

One of the reasons is the skin effect which involves pushing out the electrons from the center of conductor towards the surface as the current frequency is increasing. As a result, the higher the frequency, the smaller the effective conductor cross section which is available for the electrons, which means that the conductor resistance is increasing. Consequently, the higher the current harmonics, the higher effective cabling resistance for this harmonics, and this inevitably leads to more power losses and heating.

A classic example connected with this effect is related to neutral conductor in three-phase systems. In a system with little distortion, little unbalance and a balanced (or slightly unbalanced) receiver, the current in neutral conductor has the tendency of zeroing (it is much smaller than RMS phase currents). Such observation has tempted many designers to obtain savings by installing the cabling in such systems with neutral conductor of a smaller cross section than in phase conductors. And everything went well until the appearance of odd harmonic orders which are multiples of 3 (third, ninth, etc.). Suddenly, the neutral conductor began overheating and the measurement showed very high RMS current. Explanation of this phenomenon is however rather simple. In this example, the designer did not take into consideration two circumstances: in systems with distorted waveforms, the higher harmonics might not zero in the neutral conductor, and quite to the contrary, they may sum up, and secondly, the skin effect and high harmonic currents additionally contributed to the neutral conductor heating.

Let us try now to answer two basic questions:

What is the cause of harmonic components in voltage?

What is the cause of harmonic components in current?

Seemingly, these two questions are almost identical, but separation of current and voltage is extremely important to understand the essence of this issue.

The answer to the first question is as follows: harmonics in voltage are a result of a non-zero impedance of the distribution system, between the generator (assuming that it generates a pure sinusoid) and the receiver.

Harmonics in current, on the other hand, are a result of non-linear impedance of the receiver. Of course, it must be noted that a linear receiver to which distorted voltage is supplied will also have identically distorted current waveform.

For years, in the literature the following statement has been used "receiver generates harmonics". It should be remembered that in such case, the receiver is not a physical source of energy (as suggested by the word "generates"). The only source of energy is the distribution system. If the receiver is a passive device, the energy sent from the receiver to the distribution system comes from the same distribution system. What we have here is a disadvantageous and useless bidirectional energy flow. As discussed earlier in the section on power factor, such phenomenon leads to unnecessary energy losses, and the current "generated" in the receiver causes an additional load on the distribution system.

Let us consider the following example. A typical non-linear receiver, such as widely used switched-mode power supplies (i.e. for computers) receives power from a perfect generator of sinusoidal voltage. For the time being, let us assume that the impedance of connections between

the generator and the receiver is zero. The voltage measured on the receiver terminals will have sinusoidal waveform (absence of higher harmonics) – this is imply the generator voltage. The receiver current waveform will however include harmonic components – a non-linear receiver often takes current only in specified moments of the total sinusoid period (for example, maximum current can take place at the voltage sinusoid peaks).

However, the receiver does not generate these current harmonics, it simply takes current in a variable or discontinuous way. The whole energy is supplied only by the generator.

In the next step, we can modify the circuit by introducing some impedance between the generator and the receiver. Such impedance represents the resistance of cabling, transformer winding, etc.

Measurements of voltage and current harmonics will give slightly different results. What will change? Small voltage harmonics will appear, and in addition current frequency spectrum will slightly change.

When analyzing the voltage waveform on the receiver, one could notice that original sinusoidal waveform was slightly distorted. If the receiver took current mainly at voltage peaks, it would have visibly flattened tops. Large current taken at such moments results in larger voltage drops on the system impedance. A part of the ideal sinusoidal voltage is now dropped on this impedance. A change in the current spectrum is a result of slightly different waveform of voltage supplied to the receiver.

The example described above and “flattened tops” of the sinusoid are very frequent in typical systems to which switched-mode power supplies are connected.

6.5.1 Harmonics characteristics in three-phase system

In three-phase systems, the harmonics of given orders have a particular feature which is shown in the table below:

Order	1	2	3	4	5	6	7	8	9
Frequency [Hz]	50	100	150	200	250	300	350	400	450
Sequence (+ positive, - negative, 0 zero)	+	-	0	+	-	0	+	-	0

The row “Sequence” refers to the symmetrical components method which allows the resolution of any 3 vectors to three sets of vectors: positive sequence, negative sequence and zero sequence (more in the part related to unbalance).

Let us use an example. Assuming that a three-phase motor is supplied from a balanced, 4-wire mains (RMS phase-to-neutral voltage values are equal, and angles between the individual fundamental components are 120° each).

Sign “+” in the row specifying the sequence for the 1st harmonics means the normal direction of the motor shaft rotation. The voltage harmonics, for which the sign is also “+” cause the torque corresponding with the direction of the fundamental component. The harmonics of the 2nd, 5th, 8th and 11th order are the opposite sequence harmonics, meaning that they generate the torque which counteracts normal motor direction of rotation, which can cause heating, unnecessary energy losses, and reduced efficiency. The last group are the zero sequence components, such as the 3rd, 6th and 9th, which do not generate torque but flowing through the motor winding cause additional heating.

Based on the data from the table, it is easy to note that the series +, -, 0 is repeated for all successive harmonic orders. The formula which links the sequence with order is very simple, and for k being any integer:

Sequence	Harmonic order
----------	----------------

"+" positive	3k + 1
"-" negative	3k - 1
"0" zero	3k

The even order harmonics do not appear when a given waveform is symmetrical in relation to its average value, and this is the case in majority of power supply systems. In a typical situation, the measured even order harmonics have minimum values. If we consider this property, it turns out that the group of harmonics with the most undesirable properties is the 3rd, 9th, 15th (zero sequence), and the 5th, 11th, and 17th (negative sequence).

The current harmonics which are multiples of 3 cause additional problems in some systems. In 4-wire systems, they have a very undesirable property of summing up in the neutral conductor. It turns out that, contrary to other order harmonics, in which the sum of instantaneous current values is zeroed, the waveforms of these harmonics are in phase with each other which causes adding of the phase currents in the neutral conductor. This can lead to overheating of such conductor (particularly in the distribution systems in which this conductor has a smaller cross section than the phase conductors, and this was widely practiced until recently). Therefore, in systems with non-linear loads and large current distortions, it is now recommended that the cross section of neutral conductor is larger than that of the phased conductors. In the delta systems, the harmonics of these orders are not present in the line currents (provided these are balanced systems), but they circulate in the load branches, also causing unnecessary power losses.

Character of individual harmonics as shown in the table is fully accurate only in three-phase balanced systems. Only in such systems, the fundamental component has the exclusively positive sequence character. In actual systems, with some degree of supply voltage unbalance and the load unbalance, there are non-zero positive and negative sequence components. The measure of such unbalance is so-called unbalance factors. And this is due to this unbalance of the fundamental component and additionally the differences in amplitudes and phases of the higher harmonics, that also these harmonics will have the positive, negative and zero sequence components. The larger the unbalance, the higher the content of remaining components.

6.5.2 THD

Total Harmonic Distortion (THD) is the most widely used measure of waveform distortion. Two versions of this factor are applied in practical use:

- THD_F (THD-F or simply THD) – total harmonic distortion referred to the fundamental component,
- THD_R (THD-R) – total harmonic distortion referred to the RMS value.

In both cases, THD is expressed in percent. The definitions are given below:

$$THD_F = \frac{\sqrt{\sum_{h=2}^n A_h^2}}{A_1} \times 100\%$$

$$THD_R = \frac{\sqrt{\sum_{h=2}^n A_h^2}}{A_{RMS}} \times 100\%$$

where: A_h – RMS of the h th order harmonics,
 A_1 – RMS of the fundamental component,
 A_{RMS} – RMS waveform.

Limitation of the number of harmonics used to calculate THD is conventional and is caused mainly by measuring limitations of the device. Because the PQM-700 is capable of measuring the harmonic components up to the 40th order, the harmonics up to the 40th order are used to calculate THD.

Please note that when the waveforms are very distorted, the two definitions presented above

will give significantly different results. THD_R may not exceed 100%, but there is no such limit for THD_F and it may go up to 200% or higher. Such case can be seen when measuring very distorted current. The voltage harmonic distortion usually does not exceed a few percent (both THD_F and THD_R); for example, the limit according to EN 50160 is 8% (THD_F).

6.5.3 TDD - Total Demand Distortion

Total Demand Distortion is an indicator representing the level of the effective value of the harmonic currents referenced to the maximum demand current. It is derived from THD, and the value is expressed by the formula:

$$TDD = \frac{\sqrt{\sum_{h=2}^n I_h^2}}{I_L} \times 100\%$$

where: I_h – RMS of the h-th order harmonic,
 I_L – demand current.

Comparing the above formula with the formula for THD currents it is apparent that they differ only by the value of the denominator. The counter remains unchanged and represents the effective value of harmonics.

Demand current I_L is the maximum average value of the fundamental component, recorded during the observation period. Usually, the observation period is one week or one month.

To understand the difference between THD and TDD, see the following example. Assume that the fundamental component of the current in the circuit changes between 1000 A and 10 A. The deformation of the current waveform is more or less at the same level over the entire range of variation of the fundamental component and has a level resulting in THD_F of approx. 50%. When a graph of the THD variation in time is generated, it presents more or less constant value of 50% of the entire time interval. Note that despite the fact that in the analyzed period of time, the fundamental component changed 100-fold, the graph of THD provides no basis for conclusions on energy losses in the circuit resulting from the flow of harmonics. A similar graph of the TDD would be similar to the waveform of fundamental current component - maximum TDD values would reach 50%, while the minimum values approx. 0.5%. Thus, TDD reflects the changes in effective value of harmonics better": if the current reaches the maximum value, TDD value is close to THD, however, if the value of current in the circuit decreases, the TDD ratio also decreases.

To calculate TDD, it is required to determine or calculate I_L current. PQM analyzers offer two methods:

- automatic – I_L current is determined by the application as the maximum recorded mean value of the fundamental current component (in the whole recording range of all the measured current channels). After switching TDD recording, the analyzer automatically records the parameters required to calculate its value,
- manual – I_L current is applied by the user (in the application, during the data analysis). TDD values are calculated based on the entered value.

6.6 Unbalance

Unbalance is term related to three-phase systems and can refer to:

- supply voltage unbalance
- load current unbalance
- receiver unbalance

In three-phase systems, the voltage (current) unbalance occurs when values of three component voltages (currents) are different and/or the angles between individual phases are not equal to 120° .

The receiver unbalance occurs when impedance values of individual receiver branches are not equal.

These phenomena are particularly dangerous for three-phase motors, in which even a slight voltage unbalance can cause current unbalance that is many times larger. In such situation, the motor torque is reduced, heat losses in windings increase, and mechanical wear is faster. The unbalance also has an unfavorable effect on power supply transformers.

The most frequent reason of unbalance is uneven load on individual phases. A good example is connecting to three-phase systems of large one-phase loads, such as railway traction motors.

The PQM-700 is capable of measuring the voltage and current unbalance with a symmetrical components method. This method is based on the assumption that each set of three unbalanced vectors can be resolved to three groups of vectors: positive sequence, negative sequence and zero sequence.

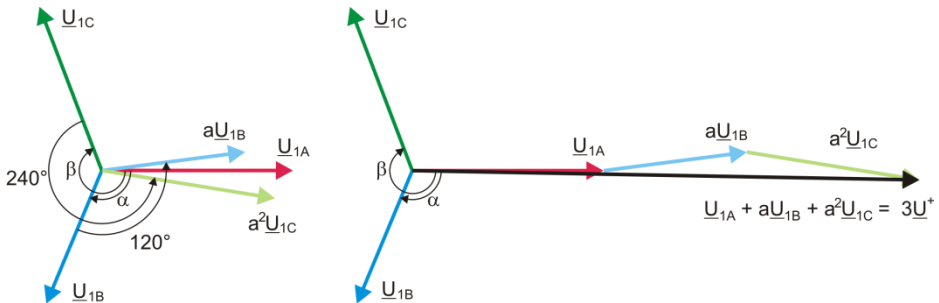

Fig. 19. Example of determination of positive sequence component.

As an example, let us use the calculation of voltage positive sequence component.

$$\underline{U}^+ = \frac{1}{3} (\underline{U}_{1A} + a\underline{U}_{1B} + a^2\underline{U}_{1C})$$

where: \underline{U}^+ is the vector of positive sequence component ,

\underline{U}_{1A} , \underline{U}_{1B} , \underline{U}_{1C} are vectors of positive sequence components of phase-to-neutral voltages U_A , U_B , U_C

$$a = 1e^{j120^\circ} = -\frac{1}{2} + \frac{\sqrt{3}}{2}j$$

$$a^2 = 1e^{j240^\circ} = -\frac{1}{2} - \frac{\sqrt{3}}{2}j$$

Fig. 19 shows a graphical representation of determination of this component. As we can see from the definition, the vector of positive-sequence component equals one third of the sum of the summands \underline{U}_{1A} , $a\underline{U}_{1B}$, $a^2\underline{U}_{1C}$. Operators a and a^2 are unit vectors with angles 120° and 240° . The

procedure is as follows: turn the voltage vector \underline{U}_{TB} by 120° counterclockwise (multiply by a) and add to the vector \underline{U}_{TA} . Then, turn the vector \underline{U}_{TC} by 240° and add to the previous sum of vectors. As a result, you get the vector $3\underline{U}^+$. The vector \underline{U}^+ is the symmetrical positive sequence component. Let us note that in case of a perfect symmetry (equal voltages and angles), the positive sequence component is equal in terms of value to the phase-to-neutral voltages.

The positive sequence component is a measure of similarity of the tested set of three-phase vectors to the symmetrical set of positive sequence vectors.

Analogously, the negative sequence component is a measure of similarity to the symmetrical set of negative sequence vectors.

The zero sequence component exists in the systems in which the sum of three voltages (or currents) is not equal to zero.

A measure of the system unbalance which is widely used in the power generation is the negative sequence and zero sequence unbalance (formulas are for the voltage).

$$u_0 = \frac{U_0}{U_1} \cdot 100\%$$

$$u_2 = \frac{U_2}{U_1} \cdot 100\%$$

where: u_0 – zero sequence unbalance,
 u_2 – negative sequence unbalance,
 U_0 – zero sequence symmetrical component,
 U_1 – positive sequence symmetrical component,
 U_2 – negative sequence symmetrical component.

The most convenient method to calculate the symmetrical components and unbalance is using the complex number calculus. The vectors parameters are amplitude of the voltage (current) fundamental component and its absolute phase shift angle. Both these values are obtained from FFT.

6.7 Detection of voltage dip, swell and interruption

Voltage dips, swells and interruptions are the mains system disturbances during which the RMS voltage significantly differs from the nominal value. Each of the three states can be detected by the analyzer when the event detection is activated and when the user defines the threshold values.

Voltage dip is a state during which the RMS voltage is lower than the user-defined voltage dip threshold. The basis for the dip measurement is $U_{RMS(1/2)}$, that is the one period RMS value refreshed every half period.

Voltage dip definition (according to the IEC 61000-4-30 standard):

The voltage dip starts at the moment when the $U_{RMS(1/2)}$ voltage decreases below the dip threshold value, and ends at the moment when the $U_{RMS(1/2)}$ voltage is equal to or greater than the dip threshold value plus the voltage hysteresis.

The dip threshold is specified at 90% of U_{nom} . During the voltage dip, the analyzer remembers the minimum recorded voltage (this is called the residual voltage U_{res} and is one of the parameters characterizing the dip) and the average voltage value.

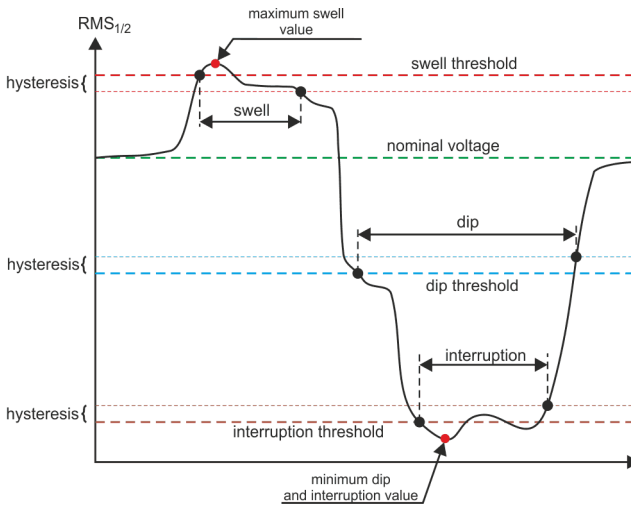

Fig. 20. Voltage swells, dips and interruptions.

Interruption is a state during which the $U_{RMS(1/2)}$ voltage is lower than the specified interruption level. The interruption threshold is usually set much below the voltage dip level, at about 1..10% of U_{nom} .

The interruption starts at the moment when the $U_{RMS(1/2)}$ voltage decreases below the interruption threshold value, and ends at the moment when the $U_{RMS(1/2)}$ voltage is equal to or greater than the interruption threshold value plus the voltage hysteresis.

During the interruption, the analyzer remembers the minimum recorded voltage and the average voltage value.

Swell is a state of increased voltage. The swell threshold is usually set at the level close to 110% of U_{nom} .

The swell starts at the moment when the $U_{RMS(1/2)}$ voltage increases above the swell threshold value, and ends at the moment when the $U_{RMS(1/2)}$ voltage is equal or less than the swell threshold value minus the voltage hysteresis. During the interruption, the analyzer remembers the maximum recorded voltage and the average voltage value.

The hysteresis for all three states is the same, and it is a user-defined percent of nominal voltage U_{nom} (**Events detection hysteresis** parameter).

The analyzer remembers the event start and end time (with a half a period accuracy).

The minimum voltage dip, interruption and swell duration is half a period.

The $U_{RMS(1/2)}$ values are determined during 1 period when the fundamental voltage component passes the zero and they are refreshed every half-period, independently for each voltage channel.

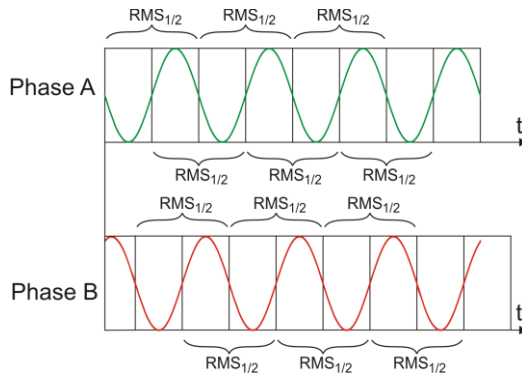

Fig. 21. Determination of the $U_{rms(1/2)}$ value.

This means that these values will be obtained at different times for different channels. Fig. 21 shows the method of the $RMS_{1/2}$ determination with two voltage phases. Information about the fundamental component's passing the zero is obtained by FFT.

6.8 CBEMA and ANSI curves

CBEMA curve was first proposed in the 70's of the last century by the organization that gave the curve its name - *Computer and Business Equipment Manufacturers Association* (now *Information Technology Industry*), which associated manufacturers of computer and office equipment. The curve was developed as a guide in the construction of power supply adapters and at the beginning it was a graph showing the tolerance of equipment to the size and duration of the disturbances in the power grid. Later, the curve was used to design equipment sensitive to voltage fluctuations as the reference range in which the equipment must operate properly. Finally the curve began to be widely used in the analyses of power-supply quality in terms of disturbances such as swell, dip, interruptions.

The vertical axis of the graph presents voltage in percent of the nominal value, whereas the horizontal axis presents time (in logarithmic scale). The middle part of the graph (between curves) represents the area of the correct operation of the device. The area above represents high voltage conditions that may damage the device or trigger over-voltage protection, while the area under the curves represents a situation of low voltage in mains, which may disconnect the power supply or temporary power shortage resulting in incorrect operation of the equipment.

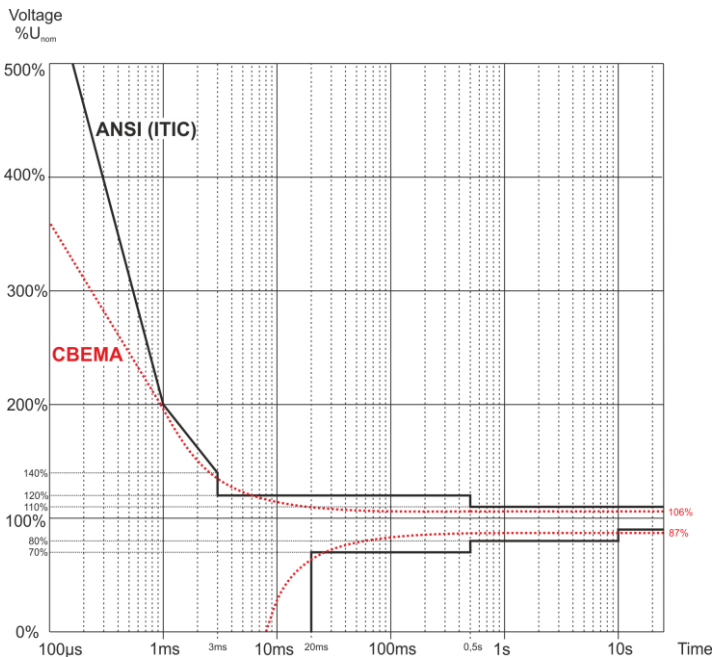

Fig. 22. Voltage tolerance curves ANSI (ITIC) and CBEMA.

As shown in the graph on Fig. 22, there is a relationship between the voltage value and the duration of the disturbance. For example, voltage swell of 200% U_{nom} and with duration of 1 ms, in typical cases, does not result in failure or malfunctioning (point between curves), but an inter-

ference of such amplitude, which lasts for half-period of the mains may be have very adverse effects (the point above two curves). Generally it is accepted that in a typical situation, events occurring in the power grid when it comes to the value of the mains voltage, should fit in the middle area of the graph (between curves) and then they should not lead to malfunction or damage to the connected equipment. Equipment manufacturers (especially power adaptors) often use this pattern while designing their products, in order to ensure their reliable operation and maintaining proper output voltage. Note, however, that the curve represents typical cases and cannot be a guarantee of correct operation for each device, as tolerance for interferences is very different.

ITIC curve is the successor of the CBEMA curve developed by ITI in 1994, and later modified to its present form in 2000. This curve has the form of two broken lines and is also known as ANSI curve, as it was adapted by ANSI (*American National Standards Institute*). Both curves are presented in Fig. 22.

Sonel Analysis software provides the ability to modify the characteristic points of the curves allowing user to adjust them to individual requirements.

6.9 Averaging the measurement results

Mains monitoring over a longer period of time means that a huge amount of data needs to be collected. If analysis of such data is to be possible at all, it is necessary to introduce the mechanisms which will reduce the data size to the values acceptable by both, humans and machines.

Lets us take the example of EN 50160 compliant power quality measurements. The basic mains test period is one week. If all 200-millisecond RMS values were to be remembered, we would get 3.024 million measurements. Processing of such amount of data would be time consuming and difficult.

Therefore, the averaging concept has been introduced which involves recording one value per a specified time interval for the analysis purposes. For the EN 50160 standard, such time interval is 10 minutes. In such case, the analyzer calculates an average 10-minute value on the basis of about three thousand 200-millisecond values (approximately, because in reality the conventional 200-millisecond value is a 10/12-period value synchronized with the mains frequency). Each average voltage value is recorded every 10 minutes which gives "only" 1008 measurement results.

Fig. 23 presents the method according to which the PQM-700 analyzer determines the average values at averaging intervals equal to or greater than 10 seconds with the 10-minute averaging time. This method meets the requirements specified in IEC 61000-4-30.

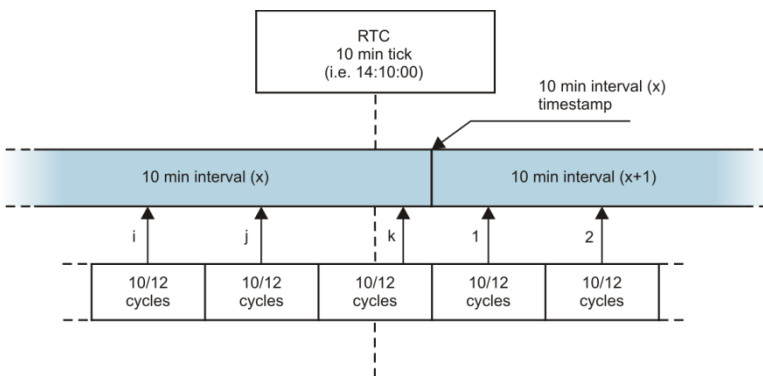

Fig. 23. Determining the averaging intervals equal to or longer than 10 seconds (with the 10-minute averaging).

The average values are synchronized with real time clock in the following manner. When the clock measures a successive full multiple of the averaging period, the instantaneous 10/12-period measurement is added as the last to the average value (k -th measurement in Fig. 23). Simultaneously, the ending averaging period is given a time stamp which relates to its end. The next 10/12-period measurement is the first in a consecutive averaging period.

Averaging with times less than 10 seconds is somewhat different. Although, they are all expressed in time units (200 ms, 1 s, 3 s, 5 s), in reality they are measured in multiples of the mains period. For example, selecting of a 3-second averaging period means averaging in the time equal to 150/180 mains periods (fifteen 10/12-period measurements).

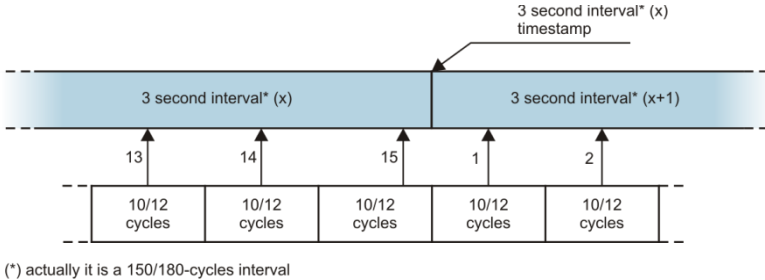

Fig. 24. Determining the averaging intervals shorter than 10 seconds (with the 3-second averaging).

The method of average values determination for such periods is shown in Fig. 24. Here, we do not have synchronization with the real time clock. When a defined number of 10/12-period measurement is collected, the instantaneous averaging period is closed and a new one starts. The time stamp corresponds to the end of the interval.

Averaging of measurement results leads to the loss of extreme values (smoothing of results). In cases when the information about a limit value of the measured parameter is essential, the user can take advantage of the option of measuring the minimum, maximum and instantaneous values in the averaging period. If a given parameter is measured in the 10/12-period time, the minimum and maximum value is respectively the smallest and the largest 10/12-period value measured in a given averaging interval. On the other hand, the instantaneous value is the last 10/12-period value in this averaging interval.

In case of RMS current and voltage, the method of searching for minimum and maximum values is more flexible and it is controlled by the **Min/Max calculation period** parameter. The user can take advantage of the following options: half period, 200 ms, 1 s, 3 s and 5 s. If the half period option is selected, the minimum and maximum values will be searched for with the highest sensitivity – to the $U_{rms(1/2)}$. As this time is increasing, additional smoothing is being introduced; for example, with 5 seconds, first a 5-second average value is calculated which is then used to search for the minimum and maximum values. This gives less sensitivity to instantaneous changes of the measured value.

Note: similarly to the averaging times shorter than 10 seconds, the 200 ms, 1 s, 3 s and 5 s times are actually the multiples of the mains period - 10/12, 50/60, 150/180 and 250/300 mains periods, respectively.

Selecting the right averaging period is not easy. To a large extent it depends on the type of disturbance in the system and the user's expectations for the final data analysis. A frequent situation is that we know only that there is a problem in the mains, and the measurements with the analyzer will only help us identify the cause. In this situation it is better to use shorter averaging times (e.g. 10 seconds), and activate the recording of minimum and maximum values (for the voltages and currents it is advisable in such situation to set the shortest possible time for deter-

mining the maximum and minimum value, i.e. half the period). Short time averaging will give more precise diagrams of changes of parameters over time, and minimums and maximums will be detected and recorded. Recording with short averaging times is performed mostly for limited time, primarily due to rapid growth of data; the aim of such recording is identifying the possible cause of a problem, and not a long-term analysis.

Recording with a short averaging time may be sufficient to evaluate the performance of the mains and disturbances in it. However, equally detailed information can probably also be obtained with longer times (in minutes) but with activated recording of minimum and maximum values and event detection. An important advantage in this situation is that the volume of recorded data is much smaller which means faster data retrieval and analysis.

On the other hand, the power quality tests are usually made according to the EN 50160. In this case, the analysis is carried out over a longer period of time (e.g. 7 days), and therefore the chosen averaging time is also long - 10 minutes.

Please note that there is no single best setting for both the averaging time and other parameters or event thresholds. Each mains system is different and so are the goals of the mains tests. Therefore, the optimal configuration of the analyzer may require several approaches and will also depend on the experience of the operator.

7 Technical specifications

- Specifications are subject to change without prior notice. Recent revisions of technical documentation are available at www.sonel.pl.
- Basic uncertainty is the uncertainty of a measurement instrument at reference conditions specified in Tab. 5.
- Provided uncertainties apply to PQM-700 without additional transformers and clamps.
- Abbreviations:
 - m.v. – reference measured value,
 - U_{nom} – nominal voltage,
 - I_{nom} – nominal current (of clamps),
 - RMS – RMS value,
 - n – harmonic order,
 - s.d. – significant digits (or significant figures) – in reference to resolution of measurement result, the value is recorded with the given number of significant digits, e.g. resolution for 230 V with 4 s.d. will be 0,1 V (notation 230,0 V); resolution for 5 A with 4 s.d. will be 0,001 A (notation 5,000 A),
 - δ_{ph} – additional uncertainty of error in the measurement of the phase between voltage and current harmonics.

7.1 Inputs

Voltage input terminals	
Number of inputs	4 (L1, L2, L3, N - 3 measuring channels)
Maximum input voltage	760 V_{RMS} 40...70 Hz or DC
Measurement category	CAT IV 300 V / CAT III 600 V / CAT II 760 V
Peak input voltage	± 1150 V
Analog passband (-3 dB)	12 kHz
Transducers	defined by user
Impedance of measurement inputs	14 M Ω
CMRR	70 dB (50 Hz)

Current input terminals

7 Technical specifications

Number of inputs	4 (3 phases + neutral) not isolated galvanically
Nominal input voltage (CT clamps)	1 V _{RMS}
Peak input voltage (CT clamps; without ADC overflow)	±3.6 V
Nominal input voltage (flexible clamps)	0.125 V _{RMS}
Peak input voltage (flexible clamps; without ADC overflow)	±0.45 V
Maximum current probes input voltage referred to earth	5 V _{RMS}
Analog passband (-3dB)	12 kHz
Input Impedance	CT clamps: 100 kΩ Flexible clamps: 12.4 kΩ
Measurement range (without transducers)	Flexible clamps F-1(A)/F-2(A)/F-3(A): 1 ...3000 A (±10000 A peak) CT clamps C-4(A), C-5(A): 1 ...1000 A (±3600 A peak) CT clamps C-6(A): 0.01...10 A (±36 A peak) CT clamps C-7(A): 0..100 A (±360 A peak)
Transformers	defined by user
CMRR	60 dB (50 Hz)

7.2 Sampling and RTC

Sampling and RTC	
A/D converter	16-bit
Sampling rate	10.24 kHz for 50 Hz and 60 Hz Simultaneous sampling in all channels
Samples per period	204.8 for 50 Hz; 170.67 for 60 Hz
PLL synchronization	40..70Hz
Reference channel for PLL	L1/A
Real-time clock	±3.5 ppm max (approx. ± 9 sec./month) in the temperature range of -20°C...+55°C

7.3 Measured parameters - accuracy, resolution and ranges

7.3.1 Reference conditions

Tab. 5. Reference conditions.

Reference conditions	
Ambient temperature	23°C ±2°C
Relative Humidity	40...60%
Voltage unbalance	≤ 0.1% for unbalance factor of negative sequence (applies only to 3-phase systems)
External continuous magnetic field	≤ 40 A / m DC ≤ 3 A / m AC for 50/60 Hz frequency
DC component of voltage and current	none
Waveforms	sinusoidal
Frequency	50 Hz ±0.2% or 60 Hz ±0.2%

7.3.2 Voltage

Voltage	Ranges and conditions	Resolution	Basic uncertainty
U_{RMS} (AC+DC)	$20\% U_{nom} \leq U_{RMS} \leq 120\% U_{nom}$ for $U_{nom} \geq 100$ V	4 s.d.	$\pm 0.5\% U_{nom}$
Crest Factor	1..10 (1..1.65 for 690 V voltage) for $U_{RMS} \geq 10\% U_{nom}$	0.01	$\pm 5\%$

7.3.3 Current

Current	Ranges and conditions	Resolution	Basic uncertainty
I_{RMS} (AC+DC)	Input path without clamps		
	0..1 V (± 3.6 V max.) – CT line 0..125 mV (± 450 mV max.) – flexible clamps line	4 s.d.	$\pm 0.2\% I_{nom}$
	Flexible clamps F-1(A)/F-2(A)/F-3(A)		
	0..3000 A (± 10 kA)	4 s.d.	Additional uncertainty $\pm 1\%$ ($\pm 2\%$ taking into account additional error due to the position)
	CT clamps C-4(A)		
	0..1000 A (± 3600 A)	4 s.d.	Additional uncertainty 0.1..10 A: $\pm (3\% + 0.1$ A) 10 A: $\pm 3\%$ 50 A: $\pm 1.5\%$ 200 A: $\pm 0.75\%$ 1000..1200 A: $\pm 0.5\%$
	CT clamps C-5A		
	0..1000 A (± 3600 A)	4 s.d.	Additional uncertainty 0.5..100 A: $\leq (1.5\% + 1$ A) 100..800 A: $\leq 2.5\%$ 800..1000 A AC: $\leq 4\%$ 1000..1400 A DC: $\leq 5\%$
	CT clamps C-6(A)		
	0..10 A (± 36 A)	4 s.d.	Additional uncertainty 0,01..0.1 A: $\pm (3\% + 1$ mA) 0.1..1 A: $\pm 2.5\%$ 1..12 A: $\pm 1\%$
	CT clamps C-7(A)		
	0..100 A (± 360 A)	4 s.d.	Additional uncertainty 0..100A: $\pm (0,5\% + 0,02A)$ (45..65Hz) 0..100A: $\pm (1,0\% + 0,04A)$ (40..1000Hz)
Crest Factor	1..10 (1..3,6 for I_{nom}) for $I_{RMS} \geq 1\% I_{nom}$	0.01	$\pm 5\%$

7.3.4 Frequency

Frequency	Ranges and conditions	Resolution	Basic uncertainty
f	40..70 Hz 10% $U_{nom} \leq U_{RMS} \leq 120\% U_{nom}$	0.01 Hz	± 0.05 Hz

7.3.5 Harmonics

Harmonics	Ranges and conditions	Resolution	Basic uncertainty
Harmonic (n)	DC, 1..40, grouping: harmonics sub-groups acc. to IEC 61000-4-7		
U_{RMS} amplitude	0..200% U_{nom}	4 s.d.	$\pm 0.15\% U_{nom}$ if m.v. $< 3\% U_{nom}$ $\pm 5\%$ m.v. if m.v. $\geq 3\% U_{nom}$ (acc. to IEC 61000-4-7 Class II)
I_{RMS} amplitude	Depending clamps used (see specifications for I_{RMS})	4 s.d.	$\pm 0.5\% I_{nom}$ if m.v. $< 10\% I_{nom}$ $\pm 5\%$ of m.v. if m.v. $\geq 10\% I_{nom}$ (acc. to IEC 61000-4-7 Class II)
Voltage THD-R (n = 2..40)	0.0...100.0% for $U_{RMS} \geq 1\% U_{nom}$	0.1%	$\pm 5\%$
Current THD-R (n = 2..40)	0.0...100.0% for $I_{RMS} \geq 1\% I_{nom}$	0.1%	$\pm 5\%$
TDD (n = 2..40)	Depending on I_L	Depending on I_L	Depending on I_L
Phase angle (voltage)	-180°...+180°	0.1 °	$\pm (n \times 1^\circ)$
Phase angle (current)	-180°...+180°	0.1 °	$\pm (n \times 1^\circ)$

7.3.6 Power and energy

Power and energy	Conditions (for power and energy $80\% U_{nom} \leq U_{RMS} < 120\% U_{nom}$)	Resolution	Basic uncertainty ⁽¹⁾
Active power Active energy	2% $I_{nom} \leq I_{RMS} < 5\% I_{nom}$ $\cos\varphi = 1$	4 s.d.	$\sqrt{2.5^2 + \Delta_{ph}^2} \%$
	5% $I_{nom} \leq I_{RMS} \leq I_{nom}$ $\cos\varphi = 1$		$\sqrt{2.0^2 + \Delta_{ph}^2} \%$
	5% $I_{nom} \leq I_{RMS} < 10\% I_{nom}$ $\cos\varphi = 0.5$		$\sqrt{2.5^2 + \Delta_{ph}^2} \%$
	10% $I_{nom} \leq I_{RMS} \leq I_{nom}$ $\cos\varphi = 0.5$		$\sqrt{2.0^2 + \Delta_{ph}^2} \%$
Reactive power Reactive energy	2% $I_{nom} \leq I_{RMS} < 5\% I_{nom}$ $\sin\varphi = 1$	4 s.d.	$\sqrt{4.0^2 + \Delta_{ph}^2} \%$
	5% $I_{nom} \leq I_{RMS} < I_{nom}$ $\sin\varphi = 1$		$\sqrt{3.0^2 + \Delta_{ph}^2} \%$
	5% $I_{nom} \leq I_{RMS} < 10\% I_{nom}$ $\sin\varphi = 0.5$		$\sqrt{4.0^2 + \Delta_{ph}^2} \%$
	10% $I_{nom} \leq I_{RMS} < I_{nom}$ $\sin\varphi = 0.5$		$\sqrt{3.0^2 + \Delta_{ph}^2} \%$
	10% $I_{nom} \leq I_{RMS} < I_{nom}$ $\sin\varphi = 0.25$		$\sqrt{4.0^2 + \Delta_{ph}^2} \%$
Apparent power Apparent energy	2% $I_{nom} \leq I_{RMS} < 5\% I_{nom}$	4 s.d.	$\pm 2.5\%$
	5% $I_{nom} \leq I_{RMS} \leq I_{nom}$		$\pm 2.0\%$
Power factor (PF)	0...1 50% $U_{nom} \leq U_{RMS} < 150\% U_{nom}$ 10% $I_{nom} \leq I_{RMS} < I_{nom}$	0.01	± 0.03
Displacement power factor ($\cos\varphi$ / DPF)	0...1 50% $U_{nom} \leq U_{RMS} < 150\% U_{nom}$ 10% $I_{nom} \leq I_{RMS} < I_{nom}$	0.01	± 0.03

(1) See sec. 7.3.7.

7.3.7 Estimating the uncertainty of power and energy measurements

The total uncertainty of active and reactive power and energy measurements and the harmonics power is based on the following relationship (additional time measurement uncertainty is omitted in case of energy as much smaller than other uncertainty types):

$$\Delta_{P,Q} \cong \sqrt{\Delta_{U_h}^2 + \Delta_{I_h}^2 + \Delta_{ph}^2}$$

where: $\delta_{P,Q}$ – uncertainty of active or reactive power measurement,

δ_{U_h} – total uncertainty of voltage harmonic amplitude measurement (analyzer, transducers),

δ_{I_h} – total uncertainty of current amplitude measurement (analyzer, transducers, clamps),

δ_{ph} – additional uncertainty caused by the error of phase measurement between the voltage and current harmonics.

The δ_{ph} uncertainty can be determined if we know the phase shift angle for a given frequency ranges. Tab. 6 presents the phase difference error between the voltage and current harmonics for the PQM-700 analyzer (without clamps and transducers).

Tab. 6. Phase error in the PQM-700 analyzer depending on the frequency

	Phase difference error				
Frequency range	0..200 Hz	200..500 Hz	500 Hz..1 kHz	1..2 kHz	2..2.4 kHz
Error	≤1°	≤2.5°	≤5°	≤10°	≤15°

The phase error caused by used transducers and clamps can be usually found in their technical documentation. Such being the case, we need to estimate the resultant phase error between the voltage and the current for a given frequency caused by all elements of the measuring circuit: current and voltage transducers, clamps, and the analyzer.

The phase uncertainty of the harmonics active power measurements can be calculated according to the following formula:

$$\delta_{ph} = 100 \left(1 - \frac{\cos(\varphi + \Delta\varphi)}{\cos\varphi} \right) [\%], \cos\varphi \neq 0$$

On the other hand, the phase uncertainty of the harmonics reactive power measurements can be calculated according to the following formula:

$$\delta_{ph} = 100 \left(1 - \frac{\sin(\varphi - \Delta\varphi)}{\sin\varphi} \right) [\%], \sin\varphi \neq 0$$

In both formulas, φ means the actual phase shift angle between the current and voltage components, and $\Delta\varphi$ means the total phase error for a given frequency. The conclusion which can be drawn from these relationships is that power measurement uncertainty for the same phase error very clearly depends on the displacement power factor between current and voltage. It is shown in Fig. 25.

Example

Calculation of measurement uncertainty of active power fundamental component.

Conditions: $\varphi = 60^\circ$, $U_{RMS} \cong U_{nom}$, $I_{RMS} = 5\% I_{nom}$.

Fundamental uncertainty equals

For the 0..200Hz frequency range, the PQM-700 phase error is $< 1^\circ$. After substituting to the equation:

$$\Delta_{ph} = 100 \left(1 - \frac{\cos(\varphi + \Delta\varphi)}{\cos\varphi} \right) = 100 \left(1 - \frac{\cos(61^\circ)}{\cos(60^\circ)} \right) = 3,04\%$$

then, the measurement uncertainty is:

$$\delta = \pm\sqrt{1,0^2 + 3,04^2} = \pm 3,20\%$$

Under the same conditions, but with the phase shift $\varphi = 10^\circ$, we will obtain:

$$\Delta_{ph} = 100 \left(1 - \frac{\cos(11^\circ)}{\cos(10^\circ)} \right) = 0,32\%$$

and the measurement uncertainty is:

$$\delta = \pm\sqrt{1,0^2 + 0,32^2} = \pm 1,05\%$$

The above calculations do not take into account additional errors caused by used clamps and transducers.

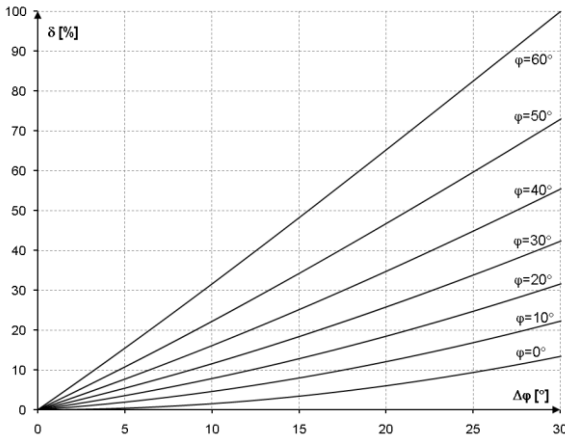

Fig. 25. Additional uncertainty from phase error depending on phase shift angle.

7.3.8 Flicker

Flicker	Ranges and conditions	Resolution	Basic uncertainty
P_{st} (10 min), P_{it} (2 h)	0.4 ... 10 for $U_{RMS} \geq 80\% U_{nom}$	0.01	$\pm 10\%$ within the values presented in tables of IEC 61000-4-15 standard

7.3.9 Unbalance

Unbalance (voltage and current)	Ranges and conditions	Resolution	Basic uncertainty
Unbalance factor for positive, negative and zero sequence	0.0% ... 10.0% for $80\% U_{nom} \leq U_{RMS} < 150\% U_{nom}$	0.1%	$\pm 0.3\%$ (absolute uncertainty)

7.4 Event detection - voltage and current RMS

U _{RMS} voltage (dips, interruptions and swells)	Range	Resolution	Basic uncertainty
U _{RMS(1/2)}	0.0%...120.0% U _{nom}	4 s.d.	$\pm 1\% U_{nom}$
Detection thresholds	Set by the user in percentage or absolute values. Event detection based on the measurement of U _{RMS(1/2)} (1-period RMS refreshed every ½ period).		
Duration	hh:mm:ss.ms	½ period	One period
Waveform record	Two periods before event + 4 periods after the event (total of 6 cycles) 204.8/170.67 (50 Hz/60 Hz) samples per period		

I _{RMS} current (min, max)	Range	Resolution	Basic uncertainty
I _{RMS(1/2)}	0.0%...100.0% I _{nom}	4 s.d.	$\pm 0.5\% I_{nom}$
Detection thresholds	Set by the user in percentage or absolute values. Event detection based on the measurement of I _{RMS(1/2)} (1-period RMS refreshed every ½ period).		
Duration	hh:mm:ss.ms	½ period	One period
Waveform record	Two periods before event + 4 periods after the event (total of 6 cycles) 204.8/170.67 (50 Hz/60 Hz) samples per period		

7.5 Event detection - other parameters

Parameter	Range	Detection method
Frequency (min, max)	40 ... 70 Hz (percentage or absolute value)	Detection based on 10-sec. measurement (acc. to IEC 61000-4-30)
Voltage crest factor (min, max)	1.0 ... 10.0	Basing on 10/12-period value
Current crest factor (min, max)	1.0 ... 10.0	Basing on 10/12-period value
Negative sequence unbalance factor for voltage (max)	0.0 ... 20.0%	Basing on 10/12-period value
Negative sequence unbalance factor for current (max)	0.0 ... 20.0%	Basing on 10/12-period value
Short-term flicker P _{st} (max)	0..20	Basing on 10-minute value
Long-term flicker P _L (max)	0..20	Basing on 2-hour value
Active power P (min, max)	Depending on the configuration	Basing on 10/12-period value (for consumed and supplied power)
Reactive power Q (min, max)	Depending on the configuration	Basing on 10/12-period value (for consumed and supplied power)
Apparent power S (min, max)	Depending on the configuration	Basing on 10/12-period value
Distortion power D / Apparent distortion power S _N (min, max)	Depending on the configuration	Basing on 10/12-period value
Power Factor PF (min, max)	0...1	Basing on 10/12-period value
Displacement power factor cosφ/DPF (min, max)	0...1	Basing on 10/12-period value
4-quadrant tanφ (min, max)	0...10	Basing on 10/12-period value

7 Technical specifications

Active energy E_P (max)	Depending on the configuration	Exceedance checked every 10/12 periods (for consumed and supplied energy)
4-quadrant reactive energy E_Q (max)	Depending on the configuration	Exceedance checked every 10/12 periods (for consumed and supplied energy)
Apparent energy E_S (max)	Depending on the configuration	Exceedance checked every 10/12 periods
Total harmonic distortion for voltage THD-F (max)	0...100%	Basing on 10/12-period value
Total harmonic distortion for current THD-F (max)	0...200%	Basing on 10/12-period value
Voltage harmonic amplitudes (max)	0 ... 100% or absolute values	Basing on 10/12-period value; Independent thresholds for all harmonics in the range of 2 ... 40
Current harmonic amplitudes (max)	0...200% or absolute values	Basing on 10/12-period value; Independent thresholds for all harmonics in the range of 2 ... 40

7.5.1 Event detection hysteresis

Event detection hysteresis	Range	Calculation method
Hysteresis	0..10% in 0.1% steps	See section 4.7.

7.6 Inrush current measurement

Range [A, %]	Resolution [A, %]	Basic uncertainty
0...100% I_{nom}	4 s.d.	$\pm 0.5\% I_{nom}$

- voltage and current measurement is carried out every $\frac{1}{2}$ period in all channels (averaging set to $\frac{1}{2}$ period)
- measurement time up to 60 seconds.

7.7 Recording

Recorder	
Averaging time ⁽¹⁾	1 s, 3 s, 10 s, 30 s, 1 min, 5 min, 10 min, 15 min, 30 min. Special mode: $\frac{1}{2}$ period (for recording waveforms with a limited recording time up to 60 sec, e.g. inrush current) ⁽²⁾
Averaging min / max for U_{RMS}	$\frac{1}{2}$ period, period, 200 ms, 1 s, 3 s, 5 s ⁽³⁾
Averaging min / max for I_{RMS}	$\frac{1}{2}$ period, period, 200 ms, 1 s, 3 s, 5 s ⁽³⁾
Waveforms	Event waveforms for voltage and current
Recording activation mode	manual starting at the first detected event scheduled (four defined time periods)
Measurement points	1, single user configuration
Recording time	Depending on the configuration
Memory	Built-in 2 GB micro-SD memory card
Memory Model	Linear
Security	Key lock to prevent unauthorized access

- (1) Averaging times shorter than 10 seconds are in fact equal to a multiple of the mains period:
200 ms = 10/12 cycles, 1 s = 50/60 periods, 3 s = 150/180 periods, 5 s = 250/300 cycles.
- (2) $U_{RMS(1/2)}$ and $I_{RMS(1/2)}$ are RMS values for one period, refreshed every half period.
- (3) Averaging periods min./max. 200 ms, 1 s, 3 s, 5 s are in fact equal to a multiple of the mains period: 200 ms = 10/12 cycles, 1 s = 50/60 periods, 3 s = 150/180 periods, 5 s = 250/300 cycles

Recorded parameters	Mean value	Minimum value	Maximum value	Instantaneous value
RMS phase-to-phase (depending on the type of system) voltage U_{RMS}	•	•	•	•
RMS phase-to-phase voltage U_{RMS} (only 3-phase wye with N and split-phase systems)	•			
RMS current I_{RMS}	•	•	•	•
Frequency f	•	•	•	•
Voltage crest factor CF U	•	•	•	•
Current crest factor CF I	•	•	•	•
Unbalance factors for negative and positive sequence, symmetrical components: negative, positive, zero (voltage) U_0, U_1, U_2, U_0, U_2	•	•	•	•
Unbalance factors for negative and positive sequence, symmetrical components: negative, positive, zero (current) I_0, I_1, I_2, I_0, I_2	•	•	•	•
Flicker factor P_{st} and P_{it}	•	•	•	•
Active power (consumed and supplied) P_+, P_-	•	•	•	•
Reactive power (consumed and supplied) $Q_{1+}, Q_{1-} / Q_{B+}, Q_{B-}$	•	•	•	•
Apparent power S	•	•	•	•
Distortion power D / Apparent distortion power S_N	•	•	•	•
Power factor PF	•	•	•	•
Displacement power factor $\cos\phi/DPF$	•	•	•	•
$\tan\phi$ factor (4 quadrants): $\tan\phi(L-), \tan\phi(C-), \tan\phi(L-), \tan\phi(C+)$	•	•	•	•
Active energy (consumed and supplied) E_{P+}, E_{P-}				•
Reactive energy (4 quadrants) $E_{Q(L-)}, E_{Q(C-)}, E_{Q(L-)}, E_{Q(C+)}$				•
Apparent energy E_S				•
Total harmonic distortion for Voltage THD-F	•	•	•	•
Total harmonic distortion for current THD-F	•	•	•	•
TDD factor	•			
Voltage harmonic amplitudes $U_{h1} \dots U_{h40}$	•	•	•	•
Current harmonic amplitudes $I_{h1} \dots I_{h40}$	•	•	•	•

7.8 Power supply, battery and heater

Power supply	
Input voltage range	100...415 V AC, 40...70 Hz 140...415 V DC
Input voltage range (including fluctuations)	90...460 V AC, 40...70 Hz 127...460 V DC
Overvoltage category	Altitude up to 4000 m: CAT IV 300 V / CAT III 415 V / CAT III 460 V (including fluctuations) Altitude 4000-5000 m: CAT III 300 V / CAT II 415 V / CAT II 460 V (including fluctuations)
Power consumption	max. 30 VA
Power consumption from mains depending on configuration (typical)	no battery charging, heater disabled, supply voltage 230 V AC 6 VA / 3 W
	no battery charging, heater enabled, supply voltage 230 V AC 11 VA / 8 W
	with battery charging, heater disabled, supply voltage 230 V AC 14 VA / 11 W
	with battery charging, heater enabled, supply voltage 230 V AC 22 VA / 16 W
	with battery charging, heater enabled, supply voltage 400 V AC 27 VA / 16 W

Rechargeable battery	
Type	Li-Ion 4.4 Ah
Operating time on battery	> 6 h
Battery charging time (fully discharged battery)	< 8 h
Charging temperature range	-10°C ...+60°C
Current consumption from battery in analyzer off mode (mains power disconnected)	< 1 mA

Heater	
Heater temperature threshold (activation)	+5°C
Heater power supply	from internal AC/DC adapter
Heater power	max. 5 W

7.9 Supported networks

Types of supported networks (directly and indirectly)	
1-phase	1-phase with a neutral conductor (terminals: L1/A, N)
2-phase (split-phase)	Split phase with a neutral conductor (terminals: L1/A, L2/B, N)
3-phase wye with N,	3-phase wye with a neutral conductor (terminals: L1/A, L2/B, L3/C, N)
3-phase delta	Three-phase delta (terminals: L1/A, L2/B, L3/C, N shorted with L3/C)
3-phase delta (Aron)	Three-phase delta (terminals: L1/A, L2/B, L3/C, N shorted with L3/C) with two current clamps
3-phase wye without N,	3-phase wye without neutral conductor (terminals: L1/A, L2/B, L3/C, N shorted with L3/C)
3-phase wye without N (Aron)	3-phase wye without neutral conductor (terminals: L1/A, L2/B, L3/C, N shorted with L3/C) with two current clamps

7.10 Supported current clamps

Types of supported current clamps	
F-1(A)	Flexible clamps (Rogowski coil), perimeter: 120 cm, measuring range 3000 A _{RMS}
F-2(A)	Flexible clamps (Rogowski coil), perimeter: 80 cm, measuring range 3000 A _{RMS}
F-3(A)	Flexible clamps (Rogowski coil), perimeter: 45 cm, measuring range 3000 A _{RMS}
C-4(A)	CT, AC clamps, measuring range 1000 A _{RMS} , 1 mV/A
C-5(A)	CT, AC/DC clamps with Hall sensor, measuring range 1000 A _{RMS} , 1 mV/A
C-6(A)	CT, AC clamps for low currents, measuring range 10 A _{RMS} , 1 mV/10 mA
C-7(A)	CT, AC clamps, measuring range 100 A _{RMS} , 5 mV/A

NOTE: Clamps with letter 'A' in the marking (e.g. F-3A) are clamps with automatic type detection in compatible devices. Other parameters are the same as in the case of clamps without automatic clamp type detection. Automatic clamp type detection is available in analyzers: PQM-700 with HWC hardware and later and with firmware 1.30 or later.

7.11 Communication

Communication	
USB	Max. bitrate: 921.6 kbit/s, Compatible with USB 2.0

7.12 Environmental conditions and other technical data

Environmental conditions	
Operating temperature range:	-20°C...+55°C
Storage temperature range	-30°C...+60°C
Humidity	10...90% with possible condensation
Operating altitude	up to 4000 m (4000-5000 m with derated measurement category CAT III 300 V / CAT II 600 V)
Ingress protection (according to IEC 60529)	IP 65 (not evaluated by UL)
Wet location	No
Reference conditions	Ambient temperature: 23°C ±2°C Humidity: 40...60%
Dimensions	200 x 180 x 77 mm (without cables)
Weight	approx. 1.6 kg
Display	5 LEDs indicating operational status
Data memory	removable microSD memory card (2 GB as standard) option of extending up to 32 GB (optional).

7.13 Safety and electromagnetic compatibility

Safety and EMC	
Compliance with	IEC 61010-1, 3 rd Edition
Measurement Category (Voltage measurement inputs)	Altitude up to 4000 m: IV 300 V / III 600 V / II 760 V Altitude 4000-5000 m: III 300 V / II 600 V pollution class 2
Overvoltage Category (AC/DC Power adapter)	Altitude up to 4000 m: IV 300 V / III 415 V / III 460 V (including fluctuations) Altitude 4000-5000 m: III 300 V / II 415 V / II 460 V (including fluctuations) pollution class 2
Insulation	Double acc. to IEC 61010-1
Electromagnetic compatibility	IEC 61326
Immunity to radio frequency interferences	IEC 61000-4-3 sinusoidal modulation 80% AM, 1 kHz 80...1000 MHz, 10 V/m 1.4...2.0 GHz, 3 V/m 2.0 ... 2.7 GHz, 1 V/m
Immunity to electrostatic discharge	IEC 61000-4-2 Air discharge: 8 kV Contact discharge: 4 kV
Immunity to conducted disturbances, induced by radio-frequency fields	IEC 61000-4-6 sinusoidal modulation 80% AM, 1 kHz 0.15...80 MHz, 10 V
Immunity to a series of electrical fast transients/bursts	IEC 61000-4-4 Amplitude of 2 kV, 5 kHz
Surge immunity	IEC 61000-4-5 Amplitude 2 kV (L-L)
Emission of radiated RF disturbances	IEC 61000-6-3 30...230 MHz, 30 dB(μV/m) at 10 m 230...1000 MHz, 37 dB(μV/m) at 10 m
Emissions of conducted interferences	IEC 61000-6-3 Levels for a quasi-peak detector: 0.15 kHz...0.5 MHz: 66 dBμV...56 dBμV 0.5 MHz...5 MHz: 56 dBμV 5 MHz...30 MHz: 60 dBμV

7.14 Standards

Standards	
Measurement methods	IEC 61000-4-30 Class S
Measurement accuracy	IEC 61000-4-30 Class S
Power Quality	EN 50160
Flicker	IEC 61000-4-15
Harmonics	IEC 61000-4-7
Safety	IEC 61010
EMC	IEC 61326
Quality standard	design, construction and manufacturing are ISO 9001 compliant

8 Accessories

The current list of accessories can be found on the manufacturer's website.

8.1 Standard accessories (non-US model version)

The standard set of equipment supplied by the manufacturer includes:

- permanently fixed cables (2.2 m) with banana plugs (6 pcs),
- crocodile clip, black (3 pcs) – **WAKROBL20K01**,
- crocodile clip, blue – **WAKROBU20K02**,
- crocodile clip, red (2 pcs) – **WAKRORE20K02**,
- mains plug with banana inputs (L1/A and N) for connecting the analyzer to socket in order to charge the battery – **WAADAAZ1**,
- software for data reading and analysing "Sonel Analysis" – **WAPROANALIZA4**,
- USB cable – **WAPRZUSB**,
- 2 GB microSD card,
- meter case L-5 – **WAFUTL5**,
- band for mounting the device on a pole (2 pcs) – **WAPOZOPAKPL**,
- bracket for mounting the analyzer on DIN (ISO) rail with stabilizing connectors – **WAPOZUCH3**,
- connectors for bands used for mounting the device on a pole (2 pcs) – **WAPOZUCH4**,
- a set of magnetic voltage adapters – 3 pcs black and 1 pc blue - **WAADAUMAGKPL**,
- built-in rechargeable battery,
- user manual,
- calibration certificate issued by an accredited laboratory.

8.2 Standard accessories (US model version)

The standard set of equipment supplied by the manufacturer includes:

- permanently fixed cables (0.1 m) with banana sockets for voltage and power inputs (6 pcs),
- 2.2 m cable with banana plugs for power supply (red, 2 pcs) - **WAPRZ2X2REBB**,
- 2.2 m cable with banana plugs (red) - **WAPRZ2X2REBBUSA**,
- 2.2 m cable with banana plugs (blue) - **WAPRZ2X2BUBBUSA**,
- 2.2 m cable with banana plugs (black) - **WAPRZ2X2BLBBUSA**,
- 2.2 m cable with banana plugs (white) - **WAPRZ2X2WHBBUSA**,
- crocodile clip, black – **WAKROBL20K01**,
- crocodile clip, blue – **WAKROBU20K02**,
- crocodile clip, white – **WAKROWH20K02**,
- crocodile clip, red (3 pcs) – **WAKRORE20K02**,
- mains plug with banana inputs (L1/A and N) for connecting the analyzer to socket in order to charge the battery – **WAADAAUS1A**,
- software for data reading and analysing "Sonel Analysis",
- USB cable – **WAPRZUSB**,
- 2 GB microSD card,
- meter case L-5 – **WAFUTL5**,
- band for mounting the device on a pole (2 pcs) – **WAPOZOPAKPL**,
- bracket for mounting the analyzer on DIN (ISO) rail with stabilizing connectors – **WAPOZUCH3**,
- connectors for bands used for mounting the device on a pole (2 pcs) – **WAPOZUCH4**,
- built-in rechargeable battery,
- user manual,
- calibration certificate issued by an accredited laboratory.

8.3 Optional accessories

Additionally, the following items that are not included in the scope of standard equipment can be purchased from the manufacturer or the distributors:

- CT clamps C-4A 1000 A AC – **WACEGC4AOKR**,
- CT clamps C-5A 1000 A AC/DC – **WACEGC5AOKR**,
- CT clamps C-6A for low currents in 10 A AC transformers – **WACEGC6AOKR**,
- CT clamps C-7A 100 A AC – **WACEGC7AOKR**,
- flexible clamps F-1A for current up to 3 kA AC (length: 120 cm) – **WACEGF1AOKR**,
- flexible clamps F-2A for current up to 3 kA AC (length: 80 cm) – **WACEGF2AOKR**,
- flexible clamps F-3A for current up to 3 kA AC (length: 45 cm) – **WACEGF3AOKR**,
- battery (replaceable by SONEL after-sale services) – **WAAKU11**,
- phase splitter AC-16 – **WAADAAC16**,
- a set of voltage adapters (threaded) – 3 pcs black, 1 pc blue and 1 pc yellow - **WAADAM4M6**,
- a case for the analyzer and standard accessories – **WAWALXL2**,
- hard case for clamps – **WAWALL2**.

8.3.1 C-4(A) current probe

The C-4(A) probe is used to measure the alternating current in medium and high power electrical installations. The output signal is voltage proportional to the measured current. The output signal is supplied by a 1.5-meter lead with a pin adapted for the socket in the meter.

The arrow located on one of the jaws indicates the current flow direction. It is assumed that the current is flowing in the positive direction if it is flowing from the source to the receiver. Such probe orientation is required for a correct power measurement.

Clamps with letter 'A' at the end of marking (e.g. C-4A) are clamps with automatic type detection in compatible devices. Other parameters are the same as in the case of clamps without automatic clamp type detection.



Fig. 26. C-4(A) probe.

Note

Currents above 1200 A must not be measured. The measurement time for currents above 1000 A shall be limited as follows:

Current range	$I \leq 1000 \text{ A}$	$1000 \text{ A} < I \leq 1200 \text{ A}$
Operation mode	continuous ¹⁾	15-minute measurement, then 30-minute break

¹⁾ For frequency $f \leq 1 \text{ kHz}$. Limitation of maximum current for continuous operation for frequencies above 1 kHz according to the relationship $I_{\text{cont}} = 1000 \text{ A}/f [\text{kHz}]$



Warning

Do not use the device on non-insulated conductors with a potential of more than 600 V in relation to the earth and a measurement category greater than III.

- **Reference conditions**

- Temperature +20...+26°C
- Humidity 20...75% RH
- Conductor position conductor centered in jaws
- Sinusoidal current frequency 48...65 Hz
- Harmonics content <1%
- Current DC component none
- Continuous magnetic field earth field (<40 A/m)
- Alternating magnetic field none
- Conductors in direct vicinity no flowing current

- **Technical parameters**

- accuracy:

Current range	Basic uncertainty ¹⁾	Phase error
0,1...10 A	$\leq 3\% + 0.1 \text{ A}$	not specified
10...50 A	$\leq 3\%$	$\leq 3^\circ$
50...200 A	$\leq 1.5\%$	$\leq 1.5^\circ$
200...1000 A	$\leq 0.75\%$	$\leq 0.75^\circ$
1000...1200 A	$\leq 0.5\%$	$\leq 0.5^\circ$

¹⁾ as % of measured value

- input signal for max. current 1 V AC
- ratio 1 mV AC/1 A AC
- frequency range 30 Hz...10 kHz
- insulation type double, according to IEC 61010-1
- measuring category acc. to IEC 61010-1 III 600 V,
- protection rating acc. to IEC 60529 IP 40, with open jaws: IP30
- dimensions 216 × 111 × 45 mm
- weight about 640 g
- jaws opening 53 mm
- open jaws height 139 mm
- maximum measured conductor diameter $\varnothing 52 \text{ mm}$
- probe lead length 1.5 m
- operating temperature -10°C...+55°C
- relative humidity <85%
- height $\leq 2000 \text{ m}$
- electromagnetic compatibility IEC 61000-6-3:2008

IEC
610
00-
6-
2:2
008

8.3.2 C-5A current probe

The C-5A probe is used to measure the alternating and direct current without interrupting the circuit with the flowing current. The measuring range is 1400 A for DC and 1000 A AC. The output signal is voltage proportional to the meas-



Fig. 27. C-5A probe.

ured current. The probe has one 1000 A measuring range, with the 1 mV/A sensitivity, DC zero adjustment knob, and LED power supply indicator.

The output signal is supplied by a 2.2-meter lead with a pin adapted for the socket in the meter.

The arrow located on one of the jaws indicates the current flow direction. It is assumed that the current is flowing in the positive direction if it is flowing from the source to the receiver. Such probe orientation is required for a correct power measurement.

Probes with letter 'A' at the end of marking (e.g. C-5A) are probes with automatic type detection in compatible devices. Other parameters are the same as in the case of probes without automatic probe type detection feature.

- **Overload:**

- Direct current (DC): up to 3000 A (continuous mode),
- Alternating current (AC): up to 1000 A in continuous mode up to the 1 kHz frequency
- Limitation of maximum current for continuous operation for frequencies above 1 kHz according to the relation: $I_{\text{cont}} = 1000 \text{ A/f [kHz]}$

- **Switching on**

- Battery powered. Move the switch to the ON position. The green LED indicates correct operation. The probe will turn off automatically after 10 minutes of non-use.
- Battery powered. Move the switch to the ON position while holding the DC ZERO button. The orange LED indicates correct operation. The probe does not turn off automatically, operating until the battery is discharged.
- External power supply. Connect the probe to the power supply via the USB port. The orange LED indicates correct operation. The probe will turn off after disconnecting the power supply.

If after switching the LED is not lit or goes off, replace the battery.

- **Signalling measurement range overflow**

If the measured current exceeds the measurement range of the probe, the OL LED is on.

- **DC zero indication correction**

- Turn on the probe.
- Make sure the jaws are closed and there is no conductor inside them.
- Connect probe to the analyzer.
- Press the DC ZERO button. The OL diode will light for approx. 3 seconds, signalling the duration of the correction.
- The OL diode will turn off when the correction is successful. If it does not go off, it means that the correction could not be performed. In this situation, check that the clamp does not have any conductor inside it and that the jaws are properly closed. Then press the DC ZERO button again or turn the clamps off and on again and repeat the procedure.

When the clamp is switched on, they recall the last saved correction.

- **Reference conditions**

- Temperature: +18...+28°C
- Humidity: 20...75% RH
- Battery voltage: 9 V
- Conductor position: conductor centered in jaws
- Current: direct (DC) or sinusoidal (AC) $f \leq 65$ Hz
- Continuous magnetic field: <40 A/m (earth field)
- Alternating magnetic field: none
- External electric field: none

• Technical specification

- Accuracy:

Current range	0.5...100 A	100...800 A	800...1000 A	1000...1400 A (DC)
Basic uncertainty ¹⁾	$\leq 1.5\% + 1$ A	$\leq 2.5\%$	$\leq 4\%$	$\leq 5\%$

¹⁾ as % of measured value

- Phase error (45...65 Hz):

Current range	3...200 A	200...1000 A
Phase error	$\leq 2^\circ$	$\leq 1.5^\circ$

- ratio: 1 mV/1 A
- frequency range: DC...30 kHz
- output impedance: 215 Ω
- Additional errors:
 - caused by current frequency:
 - 10...400 Hz: $\leq 1\%$
 - 400...7000 Hz: $\leq 3.5\%$
 - 7...10 kHz: +1,5... -12%
 - caused by relative humidity in the 10...85% range: $\leq 0.5\%$
 - caused by position of $\varnothing 20$ mm conductor: $\leq 0.5\%$
 - caused by a parallel conductor with the 50...60 Hz AC, at 23 mm from the probe: ≤ 10 mA/A
 - caused by the 400 A/m (50 Hz) external magnetic field on the centered conductor: ≤ 1.3 A
 - common mode rejection ratio: ≤ 65 dB A/V (50 Hz)

• Other data

- insulation type: double, according to IEC 61010-1
- measuring category acc. to IEC 61010-1: III 600 V (IV 300 V)
- protection rating acc. to IEC 60529: IP40
- power supply: 9 V battery (6LR61, 6LF22, NEDA 1604)
5 V DC 100 mA via type B microUSB
- operating time with alkaline battery: about 50 h
- dimensions: 237 × 97 × 44 mm
- weight: about 520 g

- maximum measured conductor diameter: Ø39 mm
- probe lead length: 2.2 m
- operating temperature: -10°C...+55°C
- humidity: ≤85% RH
- height: <2000 m
- electromagnetic compatibility: IEC 61326-1

8.3.3 C-6(A) current probe

The C-6(A) is used to measure the alternating current with frequencies up to 10 kHz in the 10 mA...10 A range.

The output signal is voltage proportional to the measured current with the 100 mV/A sensitivity. The output signal is supplied by a 1.5-meter lead with a pin adapted for the socket in the meter.

The arrow located on one of the jaws indicates the current flow direction. It is assumed that the current is flowing in the positive direction if it is flowing from the source to the receiver. Such probe orientation is required for a correct power measurement.



Fig. 28. C-6(A) probe.

Clamps with letter 'A' at the end of marking (e.g. C-6A) are clamps with automatic type detection in compatible devices. Other parameters are the same as in the case of clamps without automatic clamp type detection.

Warning	
	Do not use the device on non-insulated conductors with a potential of more than 600 V in relation to the earth and a measurement category greater than III.

• **Reference conditions**

- Temperature: +20...+26°C
- Relative humidity: 20...75%
- Conductor position: conductor centered in jaws
- Sinusoidal current frequency: 48...65 Hz
- Harmonics content: <1%
- Current DC component: none
- Continuous magnetic field: earth field (<40 A/m)
- Alternating magnetic field: none
- Conductors in direct vicinity: no flowing current

- **Technical specification**

- Accuracy

Current range	Basic uncertainty ¹⁾	Phase error
0.01...0.1 A	$\leq 3\% + 1 \text{ mA}$	not specified
0.1...1 A	$\leq 2.5\%$	$\leq 5^\circ$
1...12 A	$\leq 1\%$	$\leq 3^\circ$

¹⁾ as % of measured value

- ratio: 100 mV AC/1 A AC
- frequency range: 40 Hz...10 kHz
- insulation type: double, according to IEC 61010-1
- measurement category acc. to IEC 61010-1: III 600 V,
- protection rating acc. to IEC 60529: IP 40, with open jaws: IP 30
- dimensions: 135 × 50 × 30 mm
- weight: about 240 g
- jaws opening: 21 mm
- open jaws height: 69 mm
- maximum measured conductor diameter: $\varnothing 20 \text{ mm}$
- probe lead length: 1.5 m
- operating temperature: $-10^\circ\text{C} \dots +55^\circ\text{C}$
- humidity: $< 85\% \text{ RH}$
- height: $\leq 2000 \text{ m}$
- electromagnetic compatibility: IEC 61000-6-3:2008
IEC 61000-6-2:2008

8.3.4 C-7(A) current probe

C-7(A) Probes are used to measure alternating currents in networks of low and medium power within the range up to 100 A. The output signal is a voltage proportional to the measured current at the sensitivity of 5 mV/A. It is introduced via a cable (length: 1.5 m) ended with a plug suitable for a socket in the meter.

The arrow marked on one of the probes indicates the direction of current flow. It is assumed that the current flows in the positive direction if it flows from the source to the receiver. This orientation of probes is required for the correct power measurement.

Clamps with letter 'A' at the end of marking (e.g. C-7A) are clamps with automatic type detection in compatible devices. Other parameters are the same as in the case of clamps without automatic clamp type detection.



Fig. 29. C-7(A) probe.



Warning

Do not use non-insulated probes for conductors with a potential exceeding 300 V with respect to the ground and in systems with the measurement category higher than III.

- **Reference conditions**

- temperature: +18...+28°C
- relative humidity: <85% (non-condensing)

- **Technical data**

- test range 0...100 A AC
- frequency range 40 Hz..3 kHz
- maximum allowable continuous current 100 A AC (50/60 Hz)
- accuracy (sine wave)

Frequency	Basic uncertainty	Phase error
45...65 Hz	$\pm 0,5\% \pm 0.1 \text{ mV}$	$\leq 2^\circ$
40 Hz...1 kHz	$\pm 1.0\% \pm 0.2 \text{ mV}$	unspecified

- ratio: 5mV AC/1 A AC
- output impedance 11 Ω
- type of insulation: double, according to IEC 61010-1
- measurement category according to IEC 61010-1: III 300 V,
- dimensions: 100 × 60 × 26 mm
- weight: approx. 160 g
- maximum diameter of tested cable: $\varnothing 24 \text{ mm}$
- length of probe cables: 1.5 m
- operating temperature: 0°C...+50°C
- relative humidity: <85% (non-condensing)
- electromagnetic compatibility: IEC 61326

8.3.5 F-1(A), F-2(A), F-3(A) current probes

F-1(A), F-2(A) and F-3 flexible probes (Rogowski coil) are used to measure the alternating current of frequencies up to 10 kHz in the 1 A...3000 A range.

The only difference between the F-1(A), F-2(A) and F-3(A) flexible probes is the coil size. The electrical parameters are identical.

The output signal is voltage proportional to the derivative of the measured current, with the sensitivity equal to 38.83 mV/1000 A for 50 Hz and 46.6 mV/1000 A for 60 Hz.



Fig. 30. F-1(A) probe.



Fig. 31. F-2(A) probe.



Fig. 32. F-3(A) probe.

The output signal is supplied by a 2.2-meter lead with a pin adapted for the socket in the meter.

The arrow located on the closing unit indicates the current flow direction. It is assumed that the current is flowing in the positive direction if it is flowing from the source to the receiver. Such probe orientation is required for a correct power measurement.

Clamps with letter 'A' at the end of marking (e.g. F-3A) are clamps with automatic type detection in compatible devices. Other parameters are the same as in the case of clamps without automatic clamp type detection.

Warning

Do not use the device on non-insulated conductors with a potential of more than 1000 V CAT III and 600 V CAT IV in relation to earth.

• Reference conditions

- Temperature: +18...+22°C
- Conductor position: centered in relation to the probe loop
- Continuous magnetic field: earth field (<40 A/m)
- Alternating magnetic field: none
- External electric field: none

• Technical specification

- Rated measuring range: 1 A...3000 A ($\pm 10000A$ peak for 50 Hz)
- Input/output ratio: 38.83 mV/1000 A (50 Hz)
46.6 mV/1000 A (60 Hz)
- Basic uncertainty: $\pm 1\%$ in the 1 A...3000 A range
- Linearity: $\pm 0.2\%$
- Additional error caused by conductor position: $\pm 1\%$ max.
- Additional error caused by external magnetic field: $\pm 0.5\%$ max.
- Frequency range: 40 Hz...20 kHz

• Other data:

- insulation type: double, according to IEC 61010-1
- measuring category acc. to IEC 61010-1: III 1000 V / IV 600V, pollution degree 2
- test voltage: 7400 V_{RMS} / 1 min
- protection rating acc. to IEC 60529: IP 67
- coil diameter: 8.3 ± 0.2 mm
- diameter of the clamp connection block: 35.7 mm
- coil circumference: F-1(A): 1130 mm
F-2(A): 738 mm
F-3(A): 377 mm
- internal coil diameter (closed probe): F-1(A): 370 mm
F-2(A): 240 mm
F-3(A): 130 mm
- weight: F-1(A): about 200 g
F-2(A): about 170 g
F-3(A): about 140 g
- probe lead length: 2.2 m
- operating temperature: -30°C...+80°C
- storage temperature: -40°C...+80°C

8.3.6 Flexible current probes F-1A6, F-2A6, F-3A6 (6 kA)

Flexible probes (Rogowski coil) F-1A6, F-2A6 i F-3A6 are clamps of a double-reduced sensitivity comparing to F-1A/F-2A/F-3A, which translates into doubled measuring range for current up to 6000 A.

The output signal is voltage proportional to the measured current derivative at the sensitivity of 19.415 mV/1000 A for 50 Hz and 23.3 mV/1000 A for 60 Hz.

Other parameters are the same as for clamps F-1A/F-2A/F-3A (sec. 8.3.5).

8.3.7 Flexible current probes F-1A1, F-2A1, F-3A1 (1.5 kA)

Flexible clamps (Rogowski coil) F-1A1, F-2A1 i F-3A1 are probes of a double-increased sensitivity comparing to F-1A/F-2A/F-3A, which translates into halved measuring range for current up to 1500 A.

The output signal is voltage proportional to the measured current derivative at the sensitivity of 77.66 mV/1000 A for 50 Hz and 93.19 mV/1000 A for 60 Hz.

Other parameters are the same as for clamps F-1A/F-2A/F-3A (sec. 8.3.5).

9 Other information

9.1 Cleaning and maintenance

Note

Use only the maintenance methods presented by the manufacturer in this manual.

Clean the analyzer casing with a wet cloth, using generally available detergents. Do not use any solvents and cleaning media which could scratch the casing (powder, paste, etc.).

Clean the leads can with water and detergents, then wipe dry.

The analyzer electronic system is maintenance free.

9.2 Storage

When storing the device, observe the following recommendations:

- disconnect all leads from the analyzer,
- thoroughly clean the analyzer and all accessories,
- recharge the battery from time to time to prevent total discharging.

9.3 Dismantling and disposal

Used electric and electronic equipment should be collected selectively, i.e. not placed with other types of waste.

Used electronic equipment shall be sent to the collection point according to the Used Electric and Electronic Equipment Act.

Before sending the instrument to the collection point, do not dismantle any parts by yourself.

Observe local regulations on disposal of packages and used batteries.

9.4 Manufacturer

The manufacturer of the device and provider of guarantee and post-guarantee services:

SONEL S.A.

Wokulskiego 11
58-100 Świdnica
Poland

tel. +48 74 858 38 60

fax +48 74 858 38 09

E-mail: export@sonel.pl

Web page: www.sonel.pl

Note

Service repairs must be performed only by the manufacturer.

10 Laboratory services

SONEL Testing and Calibration Laboratory has been accredited by the Polish Center for Accreditation (PCA) - certificate no. AP 173.



AP 173

Laboratory offers calibration for the following instruments that are used for measuring electrical and non-electrical parameters.

METERS FOR MEASUREMENTS OF ELECTRICAL PARAMETERS

- voltage meters,
- current meters (including clamp meters),
- resistance meters,
- insulation resistance meters,
- earth resistance and resistivity meters,
- RCD meters,
- short-circuit loop impedance meters,
- power quality analyzers,
- portable appliance testers (PAT),
- power meters,
- multimeters,
- multifunction meters covering the functions of the above-mentioned instruments,

ELECTRICAL STANDARDS

- calibrators,
- resistance standards,

METERS FOR MEASUREMENTS OF NON-ELECTRICAL PARAMETERS

- pyrometers,
- thermal imagers,
- luxmeters.

The Calibration Certificate is a document that presents a relation between the calibration standard of known accuracy and meter indications with associated measurement uncertainties. The calibration standards are normally traceable to the national standard held by the National Metrological Institute.

According to ILAC-G24 „Guidelines for determination of calibration intervals of measuring instruments”, SONEL S.A. recommends periodical metrological inspection of the instruments it manufactures no less frequently than once every 12 months.

For new instruments provided with the Calibration Certificate or Validation Certificate at the factory, re-calibration should be performed within 12 months from the date of purchase, however, no later than 24 months from the date of purchase.

ATTENTION !

The person performing the measurements should be absolutely sure about the efficiency of the device being used. Measurements made with an inefficient meter can contribute to an incorrect assessment of the effectiveness of health protection and even human life.

NOTES

NOTES